

# HiDew

Dehumidifiers

[www.hidew.it](http://www.hidew.it)  
[info@hidew.it](mailto:info@hidew.it)



**IT** Industrial dehumidifier  
with temperature control

**ST** Dehumidifier for swimming pools  
with temperature control

**ID** Industrial dehumidifier

**SP** Dehumidifier for  
swimming pools

**USE, MAINTENANCE AND  
INSTALLATION MANUAL**

Reproduction of this document, in whole or in part, is strictly forbidden without written permission of HiDew S.r.l.

# ID - SP - IT - ST

**AVVERTENZA**  
**CAUTION****READ THIS MANUAL CAREFULLY BEFORE USING THE UNIT**

Dear Customer,

thank you for choosing our product. We are pleased to provide you with this manual to obtain the best use of our product, and for maximum comfort and increased safety.

Please read the recommendations described in the following pages carefully and make the manual available to the personnel who will be responsible for managing and maintaining the unit.

Our company is at your disposal for any questions you may have both during the unit start-up phase or at any other time.

Our Technical Department is at your disposal for any assistance and spare parts you may require, especially during routine or extraordinary maintenance.

Please find our contact details below for a faster service:

**HiDew**  
Dehumidifiers

HiDew S.r.l  
info@hidew.it - www.hidew.it

Operational Headquarters  
Via dell'Artigianato, 5- 35026 - Conselve (PD)- Italy  
Tel +39 049 9502511

Registered Office  
Viale Spagna, 31/33 - 35020 - Tribano (PD)- Italy  
Tel +39 049 9588511- Fax +39 049 9588522

**TABLE OF CONTENTS**

<b>1</b>	<b>INTRODUCTION.....</b>	<b>5</b>
1.1	LIABILITY.....	6
1.2	OPERATING RULES .....	6
1.3	INTENDED USE .....	7
1.4	RESIDUAL RISK AREAS.....	7
1.5	INTERVENTION AND MAINTENANCE.....	8
1.6	GENERAL SAFETY RULES.....	9
<b>2</b>	<b>DESCRIPTION OF THE PRODUCT .....</b>	<b>10</b>
2.1	SERIES .....	10
2.2	INTERNAL COMPONENTS .....	11
2.3	STRUCTURE .....	11
2.4	OPTIONS AVAILABLE .....	12
2.5	OPERATING LIMITS.....	15
2.6	ELECTRIC CIRCUITS.....	15
2.7	REFRIGERATING AND HYDRAULIC CIRCUITS.....	15
<b>3</b>	<b>BASIC USER TERMINAL .....</b>	<b>16</b>
3.1	KEYS AND DISPLAY .....	16
3.2	MAIN COMMANDS.....	17
3.3	USER MENU .....	17
3.4	OTHER FUNCTIONS.....	17
<b>4</b>	<b>ADVANCED USER TERMINAL.....</b>	<b>18</b>
4.1	USE OF KEYS.....	18
4.2	MAIN PAGE .....	19
4.3	OTHER USER PAGES.....	19
4.4	USER MENU PAGES .....	20
4.5	TIME BAND SETTINGS.....	23
<b>5</b>	<b>TECHNICAL DATA .....</b>	<b>26</b>
5.1	TECHNICAL DATA TABLE .....	26
5.2	PERFORMANCE CURVE .....	33
5.3	OPERATIONAL DIAGRAM.....	35
<b>6</b>	<b>MAINTENANCE AND TROUBLESHOOTING .....</b>	<b>38</b>
6.1	TROUBLESHOOTING .....	38
6.2	ORDINARY MAINTENANCE .....	39
6.3	MAINTENANCE TABLE.....	40
6.4	MAINTENANCE REGISTER.....	40
<b>7</b>	<b>DECOMMISSIONING THE SYSTEM .....</b>	<b>41</b>
7.1	ENVIRONMENTAL PROTECTION.....	41
7.2	WASTE ELECTRICAL AND ELECTRONIC EQUIPMENT MANAGEMENT (WEEE).....	41
<b>8</b>	<b>INSTALLATION .....</b>	<b>42</b>
8.1	INTRODUCTION .....	42
8.2	PLACEMENT .....	43
8.3	HYDRAULIC AND ELECTRICAL CONNECTIONS .....	43
8.4	CLEARANCES.....	44
8.5	REFRIGERATING CONNECTIONS (IT - ST ONLY) .....	45
8.6	COMMISSIONING.....	50
8.7	MODIFYING INSTALLER PARAMETERS .....	51
8.8	INSTALLER MENU (ADVANCED CONTROL).....	52
8.9	CALIBRATION AND CANALIZATION .....	55
<b>9</b>	<b>CONTROLS FREQUENCY ACCORDING TO REG. FGAS 517/2014 UE AND ITALIAN DPR 146/2018.....</b>	<b>56</b>
9.1	MODEL ID-SP .....	56
9.2	MODEL IT-ST .....	56
9.3	INFORMATION ABOUT CONTROLS .....	57
<b>10</b>	<b>NOTES .....</b>	<b>58</b>

## 1 INTRODUCTION

This manual indicates the intended use of the unit and provides instructions on transportation, installation, assembly, adjustment and use. It provides information on maintenance, ordering of spare parts, the presence of residual risks and personnel training.

The user manual must be read and used as follows:

- Every unit operator and the staff in charge must carefully read the entire manual and comply with the indications given;
- The employer is obliged to ensure that the operator possesses the skills required to operate the unit and has carefully read the manual; the employer must also provide the operator with details about the risk of accidents, especially those deriving from noise, about the personal protective equipment provided and the general accident prevention regulations, required by international laws or regulations or those applicable in the country of use.
- The manual must always be available to the user, managers and operators in charge of transportation, installation, use, maintenance, repairs and final dismantling.
- Keep the manual away from sources of humidity and heat and treat it as an integral part of the unit for its entire duration, passing on the manual to any other user or subsequent owner of the unit;
- Make sure that any update is included in the text;
- Under no circumstances are any parts of the manual to be removed, torn or rewritten. If the manual is mislaid or partially damaged and, therefore, the contents can no longer be fully read, a new manual should be requested from the manufacturer by communicating the serial number of the machine found on the data plate.

Pay utmost attention to the following symbols. Their purpose is to highlight specific information such as:



*Dangerous situations that could arise while using the unit, in order to guarantee personal safety.*



*Dangerous situations that could arise while using the unit, in order to prevent damaging property and the unit itself.*



*Additional information or suggestions for the unit to be used correctly.*

The manufacturer has the right to update the production and manuals, without being obliged to update previous versions, except for exceptional cases.

This manual reflects the applicable technology at the time the unit is sold and cannot be considered inadequate due to subsequent updates based on new technology.

For any requests for updates of the use and maintenance manual or supplements, which are to be considered an integral part of the manual, please refer to the contact information indicated in this manual.

Contact the manufacturer for further information and to submit any proposals on how to improve the manual.

The manufacturer kindly asks you to communicate the address of the new owner if the unit is passed on to third parties, in order to facilitate the forwarding of any supplements of the manual to the new user.

## 1.1 LIABILITY

The unit is covered by the warranty in accordance with the contractual agreements established at the time of sale.

The manufacturer is deemed exempt from any liability and obligation, and the warranty required by the sales contract will be voided for any accident or damage to persons or property, which may derive from:

- |                                                                                                                        |                                                                                                                                                                                                                                    |
|------------------------------------------------------------------------------------------------------------------------|------------------------------------------------------------------------------------------------------------------------------------------------------------------------------------------------------------------------------------|
|  <p><b>ATTENZIONE<br/>WARNING</b></p> | <ul style="list-style-type: none"> <li>- <b>failure to comply with the instructions provided in this manual regarding unit management, use, maintenance and accidents beyond the normal and proper use of the unit;</b></li> </ul> |
|------------------------------------------------------------------------------------------------------------------------|------------------------------------------------------------------------------------------------------------------------------------------------------------------------------------------------------------------------------------|
- 
- alterations made to the unit and safety devices without prior written authorisation from the manufacturer;
  - attempts to perform the repairs yourself or by an unauthorised technician;
  - failure to perform regular maintenance work or maintenance performed using non-original spare parts.

In any case, if the user attributes the accident to a defect in the unit, he must prove that the damage caused was a main and direct consequence of this "defect".

## 1.2 OPERATING RULES

The operating rules described in this manual are an integral part of the unit supply.

These rules are also intended for operators previously trained specifically to operate this type of unit and contain all the necessary and important information for operating safely and optimal use of the unit.

Rushed and incomplete training leads to improvisation, which is the cause of many accidents.

Read carefully and comply strictly with the following recommendations before starting work:

- |                                                                                                                          |                                                                                                                                                                                                                                                                                                                                                                                                                                                                                                                                                                                                                                                                                                                                                                                                             |
|--------------------------------------------------------------------------------------------------------------------------|-------------------------------------------------------------------------------------------------------------------------------------------------------------------------------------------------------------------------------------------------------------------------------------------------------------------------------------------------------------------------------------------------------------------------------------------------------------------------------------------------------------------------------------------------------------------------------------------------------------------------------------------------------------------------------------------------------------------------------------------------------------------------------------------------------------|
|  <p><b>ATTENZIONE<br/>WARNING</b></p> | <p><b><i>the unit must be started up for the first time only by qualified personnel authorised by the manufacturer;</i></b></p> <ul style="list-style-type: none"> <li>- When installing or servicing the unit, the rules indicated in this manual must be complied with, together with those on board the unit and, in any case, all necessary precautions must be taken;</li> <li>- Potential accidents to persons and property can be prevented by following these technical instructions with reference to the Machinery Directive 2006/42/EC and subsequent amendments. In all cases, always comply with the national safety regulations;</li> <li>- Do not remove or damage the safety devices, labels and notices, especially those imposed by law and replace them if no longer legible.</li> </ul> |
|--------------------------------------------------------------------------------------------------------------------------|-------------------------------------------------------------------------------------------------------------------------------------------------------------------------------------------------------------------------------------------------------------------------------------------------------------------------------------------------------------------------------------------------------------------------------------------------------------------------------------------------------------------------------------------------------------------------------------------------------------------------------------------------------------------------------------------------------------------------------------------------------------------------------------------------------------|

*The Machinery Directive 2006/42/EC provides the following definitions:*

**DANGER ZONE:** *any zone within and/or around machinery in which a person is subject to a risk to his health or safety.*

**EXPOSED PERSON:** *any person wholly or partially in a danger zone.*

**OPERATOR:** *the person or persons installing, operating, adjusting, maintaining, cleaning, repairing or moving machinery.*

- |                                                                                                                          |                                                                                                                                                                                    |
|--------------------------------------------------------------------------------------------------------------------------|------------------------------------------------------------------------------------------------------------------------------------------------------------------------------------|
|  <p><b>AVVERTENZA<br/>CAUTION</b></p> | <p><i>All the operators must comply with international accident prevention regulations and those applicable in the country of use in order to prevent potential accidents.</i></p> |
|--------------------------------------------------------------------------------------------------------------------------|------------------------------------------------------------------------------------------------------------------------------------------------------------------------------------|

Please note that the European Union has issued certain Directives regarding health and safety of workers, including: Directive 89/391/EEC, 89/686/EEC, 89/654/EEC, 89/655/EEC, 89/656/EEC, 86/188/EEC, 92/58/EEC and 92/57/EEC, which every employer is obliged to comply with and enforce.

The units have been designed and built according to the current state-of-the-art and technical rules in force.

Applicable laws, provisions, regulations, decrees and directives for such machinery have been complied with.

The materials used and the parts of equipment, as well as production procedures, quality and control assurance comply with the highest standards of safety and reliability.

Unit performance, continuous operation and durability are maintained by using the above-mentioned materials and parts for the purposes specified in this user manual, handling them with due care and performing thorough maintenance and up-to-standard service.

### 1.3 INTENDED USE

**The ID units** are industrial dehumidifiers designed for use in environments where high humidity damages the structure or the product;

**The SP units** are dehumidifiers for swimming pools designed for use in environments where high humidity causes discomfort and where corrosive substances, such as chlorine, are present;

**The IT units** are industrial dehumidifiers with temperature control designed for use in environments where high humidity damages the structure or the product and where it is necessary to heat or cool the air;

**The ST units** are dehumidifiers for swimming pools with temperature control designed for use in environments where high humidity causes discomfort and where corrosive substances, such as chlorine, are present and it is necessary to heat or cool the air.

Its use is recommended within the operating limits indicated in this manual.



*Install the unit in places where there is no risk of explosion, corrosion, fire and where there are no vibrations and electromagnetic fields. It is also prohibited to operate in any way other than that stipulated or disregard required safety operations.*



*The units are designed for use in swimming pools or places where substantial amounts of chlorine and other corrosive substances are used. It is extremely important to leave the unit switched on as much as possible to avoid the deposit of corrosive substances which could otherwise damage it.*



**DO NOT SWITCH ON THE UNIT IMMEDIATELY AFTER HAVING PLUGGED IN IT**  
 Leave the unit plugged in at least for 2 hours with all magnetothermals active in order to obtain a correct oil distribution.

- The unit will be turned off for routine and extraordinary maintenance, turn it on again as soon as possible.
- Do not stop the unit for seasonal breaks.

### 1.4 RESIDUAL RISK AREAS



*It has not been possible to eliminate certain residual risks during the design phase, found in some areas of the unit, or protect them with guards due to specific features of the unit. Every operator must be aware of the residual risks present in this unit and exercise extreme caution to avoid any accidents.*

Residual risks:

- risk of short circuit and fire caused by short circuit
- risk of explosion due to the presence of pressurised circuits and risk of pollution due to the presence of refrigerant in the circuit
- risk of burns due to the presence of very hot pipes
- risk of shearing

## 1.5 INTERVENTION AND MAINTENANCE

It is important to remember that the user manual can never replace adequate user experience. This manual represents a reminder of the main activities to be performed by operators who have received specific training, for example by attending training courses held by the manufacturer, with reference to particular maintenance operations.

Carefully read the following recommendations:

- Constant, accurate preventive maintenance guarantees a high level of safety when operating the unit. Never postpone any repairs required which should be only be carried out by specialised personnel, using original spare parts.
- Plan each intervention carefully;
- The operator's workplace must be kept clean, tidy and free from objects that could hinder movements.
- Operators must not perform awkward operations, in uncomfortable positions, that could compromise their balance;
- Operators must pay attention to the risk of clothing and/or hair being caught or entangled in moving parts. A cap should be worn to keep long hair in place;
- Chains, bracelets and rings can also pose a hazard;
- The workplace must be adequately lit for the work to be carried out. Insufficient or excessive lighting can pose a risk;
- Wait about 10 minutes after switching the unit off before performing any maintenance in order to prevent burns;



- ***do not repair the high-pressure pipes with welding;***
- ***the fluids under pressure in the refrigerating circuit and the presence of electrical components may cause hazardous situations during installation and maintenance work;***

- Limit the amount of time the refrigerating circuit is open. Even if briefly exposed to air, oils tend to absorb large amounts of humidity, which results in the formation of weak acids;
- Only qualified personnel may perform work on the unit;
- Before performing any kind of work or maintenance on the unit, make sure it has been disconnected from the power supply;
- Make sure the safety devices function correctly and you have no doubts on how they work; otherwise, do not start-up the unit;
- Only use the tools indicated by the manufacturer of the unit. In order to prevent personal injury, do not use worn or damaged, poor quality or makeshift tools;



- ***once the unit has been cleaned, the operator must make sure there are no worn or damaged parts or others that are not fastened securely; otherwise, a maintenance technician should be contacted;***

- Always keep the unit installation area clean and tidy. Oil and grease stains, and scattered tools or broken parts are hazardous as staff could slip or fall;
- It is prohibited to use flammable fluids to clean the unit.

Do not use diesel, petroleum or solvents to clean the unit as they leave an oily film that encourages dust to settle, while solvents (even if weak) damage the paintwork and encourage the formation of rust. If a jet of water penetrates the electrical equipment, the contacts oxidise and the unit may malfunction. Therefore, do not use jets of water or steam on the sensors, connectors or any electrical part.

Make sure that the pressurised pipes, or other components subject to wear, are intact. Also make sure there are no leaking fluids or hazardous substances.

Should there be a leak, the operator must not restart the unit before having resolved the problem.



**1.6 GENERAL SAFETY RULES**

**1.6.1 WEARING PROTECTIVE CLOTHING**

Every operator must use personal protective equipment such as gloves, helmet, safety goggles, safety shoes and noise protection ear muffs.



**1.6.2 FIRE EXTINGUISHER AND FIRST AID**

Place a first aid kit and an extinguisher near the unit.  
Periodically check that the fire extinguishers are loaded and all operators know how to use them.  
If a fire breaks out, use the fire extinguisher according to the relative regulations in force and contact the fire brigade.  
Periodically check that the first aid kit is complete.  
Make sure the emergency telephone numbers are readily available and nearby.



*The owner of the property where the unit is installed is responsible for providing the fire extinguisher and the first aid kit.*

**1.6.3 MAINTENANCE AND INSPECTION WARNING SIGNS**

Place a notice with the wording: “UNDER MAINTENANCE” on all sides of the unit.  
Carefully check the unit according to the list of operations specified in this manual.



**1.6.4 SAFETY WARNING SIGNS**



Generic danger



Shearing risk

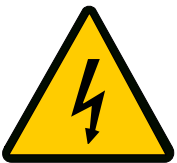

Electric voltage hazard



Hazard: moving mechanical parts



Risk of burns

**2 DESCRIPTION OF THE PRODUCT**

The ID, SP, IT and ST series of dehumidifiers are designed for use in commercial and industrial settings and swimming pools with high latent pressure load where 24h/day operation is required. They are typically installed in places, such as swimming pools, dairies, basements, laundries, food seasoning chambers, warehouses and anywhere in general where the formation of condensation damages the structure or product.

The IT and ST units are suitable where, in addition to the dehumidifier, you need to control the temperature and either heat or cool. This solution avoids the installation of two separate units (a dehumidifier and an air conditioner), thus reducing purchase, maintenance and power consumption costs.

The ID, SP, IT and ST dehumidifiers combine avant-garde technical solutions with pleasing aesthetics.

These units have been designed to be connected to rigid ducts.

The exclusive use of high quality components in the refrigerating, hydraulic, air duct and electrical components makes these units state-of-the-art dehumidifiers in terms of efficiency, reliability and noise output. They have also been designed to allow easy inspection and maintenance work.

A large number of accessories also allow to solve any type of request, and if the standard range and accessories do not meet the customer's needs, the Company is available to create specific solutions.



**2.1 SERIES**

There are 20 models classified by frame and dehumidification capacity.

**2.1.1 Frame 2**

0100	0130	0160	0190
------	------	------	------

**2.1.2 Frame 3**

0210	0260	0300
------	------	------

**2.1.3 Frame 4**

0350	0450	0580
------	------	------

**2.1.4 Frame 5**

0750	0950
------	------

**2.1.5 Frame 6**

1100	1400
------	------

**2.1.6 Frame 7**

1500	1700	1900	2200
------	------	------	------

**2.1.7 Frame 8**

3000
------

**2.1.8 Frame 9**

4500
------

Units with the same frame have the same external measure.  
The numeric value indicates the dehumidification capacity in liters per day

## 2.2 INTERNAL COMPONENTS

### 2.2.1 Refrigerating circuits

The refrigerating circuit is entirely realized in-house, using only major brand components, Cu-DHP quality copper pipes and qualified operators and processes in accordance with Pressure Equipment Directive 97/23/EC. Units have a single or double refrigerating circuit with R410A refrigerant.

Refrigerating circuit components:

- Compressors are scroll-type of major international brands. The motors are thermally protected by an internal protection that controls the winding temperature and disables the power supply when needed.
- molecular sieve filter dryer
- thermostatic valve
- liquid indicator
- solenoid valve shut-off valve,
- Schrader valve for checks and/or maintenance
- heat exchanger coils; coils with surface treatment for greater resistance to corrosive atmospheres are used in the units for swimming pools
- copper pipe and aluminum fin

### 2.2.2 Ventilation

It is available three type of ventilators:

- Centrifugal standard static pressure
- Centrifugal high static pressure
- Radial electronic with inverter (maximum efficiency in terms of operating cost)

*Standard centrifugal fans* have forward-curve blades; they are directly coupled or belt driven with an asynchronous electric motor

*Radial electronic fans* have backward-curve blades, directly coupled to an electric brushless motor with permanent magnets (lower power consumption and noise emission)

Radial electronic fans allow to:

- Use ACF (Automatic Control Flow) option which allows unit to automatically adjust the airflow without requiring manual adjustment. The airflow is kept to the desired value.
- Use “Low flow recirculation” function that, in order to save energy, allows to reduce fans speed in case of no air treatment.

## 2.3 STRUCTURE

The unit is manufactured to an exclusive design which not only makes it look aesthetically pleasing, but also allows total access to all the components when the unit is closed. This aspect together with the use of top-quality devices reduces the sound levels to an absolute minimum.

Most of the panels can be removed to allow complete access to the unit. For routine maintenance, access is required to the filters, fans and compressor compartment which is facilitated by removable panels, allowing unhindered work access.

All the screws and fasteners are made of non-oxidizing materials, stainless steel or carbon steels with surface passivation treatments.

The layout of the components guarantees easy access and optimal weight distribution on the base of the unit.

**2.4 OPTIONS AVAILABLE**

OPTIONS AND FUNCTIONS	ID - SP basic control	IT - ST basic control	ID - SP - IT - ST advanced control
External version	OPTION	OPTION	OPTION
Filter holder frame for ducted suction with G2 filters	OPTION	OPTION	OPTION
Filter holder frame for ducted suction with G4 filters	OPTION	OPTION	OPTION
Filter holder frame for ducted suction with F7 filters	OPTION	OPTION	OPTION
High efficiency, electronic, radial fans with inverter and brushless motor	—	—	OPTION
ACF = Automatic control flow	—	—	OPTION
High pressure centrifugal fans	OPTION	OPTION	OPTION
Water post-heating coil with modulating 3-way on/off valve	OPTION	—	—
Water post-heating coil with modulating 3-way valve	—	—	OPTION
Oversized water post-heating coil with modulating 3-way on/off valve	OPTION	—	—
Oversized water post-heating coil with modulating 3-way valve	—	—	OPTION
Water post-cooling coil with 3-way on/off valve	OPTION	—	—
Water post-cooling coil with modulating 3-way valve	—	—	OPTION
Desuperheater	OPTION	OPTION	OPTION
Desuperheater for pool water	OPTION	OPTION	OPTION
Dirty filter sensor	—	—	OPTION
Soft start	OPTION	OPTION	OPTION
Silent version with soundproofing of the compressor compartment	OPTION	OPTION	OPTION
Clock board - time bands	—	—	OPTION
Mechanical humidistat	OPTION	OPTION	—
Electronic timed hygrometer	OPTION	OPTION	—
Hot gas defrost	OPTION	OPTION	OPTION
Remote user terminal	—	—	OPTION
Pressure gauges	OPTION	OPTION	OPTION
Duct temperature and humidity sensor	—	—	OPTION
Electric post-heating coils	OPTION	—	OPTION
Modbus serial board	—	—	OPTION
Lonworks serial board	—	—	OPTION
Bacnet serial board	—	—	OPTION
Konnex serial board	—	—	OPTION
Swivel wheels	OPTION	—	OPTION
Thermal insulation 20 mm thickness	OPTION	OPTION	OPTION

**2.4.1 Advanced control**

Advanced control consists of a programmable board and a graphic display which allows numerous functions and options. All the software for managing and optimising the refrigerating circuit, the electronic and electro-mechanical components is implemented and developed in-house by a highly specialised team. Advanced control allows to install numerous options which are not available with basic control. *Personalised software is available on request in special version.*

**2.4.2 Version for outdoor installation**

The unit can be installed outdoor thanks to structural and electrical modifications. *This option combined with any of the water coils requires the advanced control.*

**2.4.3 Filter holder frame for suction ducting with G2 filters**

It consists of a G2 filter and a frame installed on the intake of the dehumidifier which makes easier to connect the suction ducts and remove the air filters when the duct is installed.

#### 2.4.4 Filter holder frame for suction ducting with G4 filters

It consists of a G4 filter and a frame installed on the dehumidifier intake which makes easier to connect to the suction ducts and remove the air filters when the duct is installed.

#### 2.4.5 Filter holder frame for suction ducting with F7 filters

It consists of a F7 filter and a frame installed on the dehumidifier intake which makes easier to connect to the suction ducts and remove the air filters when the duct is installed.

#### 2.4.6 High efficiency electronic radial fans with inverter and brushless motor

The electronic radial fans with backward-curved blades connected to a brushless motor and in-built inverter are the new standard in ventilation technology for industrial environments. These fans combine high aerodynamic efficiency with noise minimisation.

The in-built inverter means that speed can be modulated, which when combined with the ACF system makes it particularly suitable for installations where accurate air flow control is important.

#### 2.4.7 ACF: Automatic control flow

This option allows to set a constant airflow; if pressure drops vary from the estimated value, the unit will automatically adjust to maintain the airflow required.

*This option is available only with high-efficiency electronic radial fans with inverter and brushless motor.*

#### 2.4.8 High prevalence centrifugal fans

These fans guarantee a static pressure up to 200 Pa.

*Higher prevalence is available on request in special version.*

*It is possible to choose only ONE coil for air treatment, it is not possible to install more than one coil.*

#### 2.4.9 Hot water coil with 3-way on/off valve

A hot water coil with a 3-ways on/off valve allows to heat the room when supplied with hot water from a boiler; it follows a range of temperatures set on the user control.

*This option cannot be combined with electrical heater, oversized hot water coil or chilled water coil.*

#### 2.4.10 Hot water coil with 3-way modulating valve

A hot water coil with a 3-ways modulating valve allows to heat the room when supplied with hot water from a boiler; it follows a range of temperatures set on the user control.

*The modulating valve is not available for units up to model 300, instead there is a on/off valve.*

#### 2.4.11 Oversized hot water coil with 3-way on/off valve

An oversized hot water coil with a 3-ways on/off valve allows to heat the room when supplied with hot water from a boiler; it follows a range of temperatures set on the user control.

*This option cannot be combined with electrical heater, oversized hot water coil or chilled water coil.*

#### 2.4.12 Oversized hot water coil with 3-way modulating valve

An oversized hot water coil with a 3-ways modulating valve allows to heat the room when supplied with hot water from a boiler; it follows a range of temperatures set on the user control.

*The modulating valve is not available for units up to model 300, instead there is a on/off valve.*

#### 2.4.13 Chilled water coil with 3-way on/off valve

A chilled water coil with a 3-ways on/off valve allows to cool the room when supplied with chilled water from a chiller; it follows a range of temperatures set on the user control.

*This option cannot be combined with electrical heater, oversized hot water coil or hot water coil.*

#### 2.4.14 Chilled water coil with 3-way modulating valve

A chilled water coil with a 3-ways modulating valve allows to cool the room when supplied with chilled water from a chiller; it follows a range of temperatures set on the user control.

*The modulating valve is not available for units up to model 300, instead there is a on/off valve.*

#### 2.4.15 Desuperheater

A brazed plate heat exchanger allows to recover heat heating up water. It is ideal wherever water needs to be heated.

It is not possible to heat directly pool water, it is necessary to use a second heat exchanger.

#### 2.4.16 Desuperheater for pool water

A tube-in-tube heat exchanger allows to recover heat heating up water. It is ideal for public and private swimming pools where the pool water needs to be heated.

#### 2.4.17 Dirty filter sensor

It consists of a differential pressure switch which detects when the filters are clogged, preventing the unit from working properly.

With this option, the filters are cleaned when indicated and not according to a set timetable.

#### 2.4.18 Softstart

It consists of a softstart device for each compressor with the aim of reducing the inrush current on start-up, following a pre-set ramp.

**2.4.19 Silent version with compressor soundproofing**

The noise emitted by the compressor is decreased, so the dehumidifier is particularly silent. A soundproofing material is installed in the compressor compartment.

**2.4.20 Clock board - time scheduling**

An additional clock board and a control software allow the dehumidifier to function following daily programs. It is possible to set the values for humidity, temperature, and unit on-off for each time band.

**2.4.21 Mechanical hygrostat**

A hygrostat, when placed in the room and connected to the dehumidifier, activates dehumidification when the humidity set is exceeded.

**2.4.22 Electronic chrono – hygrostat**

Wall-mounted device that connected to the unit allows to activate it following a humidity set. Humidity set could be combined with time band program.

**2.4.23 Hot gas defrost**

It consists of a gas valve that injects hot gas into the evaporator coil allowing quick defrost and extending the minimum temperature limit for the dehumidifier.

**2.4.24 Remote user terminal**

Additional, wall-mounted device which controls the functions of the dehumidifier. The built-in electronic control and the remote terminal are identical in size, appearance and electronics (hardware).

**2.4.25 Manometers**

The units can be supplied with manometers, one on the high pressure and one on the low pressure side, for each refrigerating circuit. They allow to instantly display the pressure levels of the circuit.

**2.4.26 Temperature and humidity probe for duct installation**

Temperature and humidity probe already connected to the electrical panel and ready to be installed in the extraction fan duct.

**2.4.27 Electrical heaters**

Electrical heaters allow to heat supply air. In case of overheating a thermostat immediately switches off the coils and signals an alarm.  
*It cannot be combined with water coils with the basic control unit.*

**2.4.28 Modbus serial board**

Connection slot for a RS485 Modbus serial board that allows supervision by a remote unit or a home automation system. (additional information available on request contacting the technical department).

**2.4.29 Pivoting wheels**

This option allows the unit to be easily transported where the dehumidification is required.  
*Available up to model 0950.*

**2.4.30 Thermal insulation, thickness 20 mm**

Unit frame is completely covered with a thermal insulant, it allows to reduce thermal exchange between unit and the room where it is installed.

## 2.5 OPERATING LIMITS

Outside the limits indicated below, unit operation is not guaranteed.

### 2.5.1 ID - IT

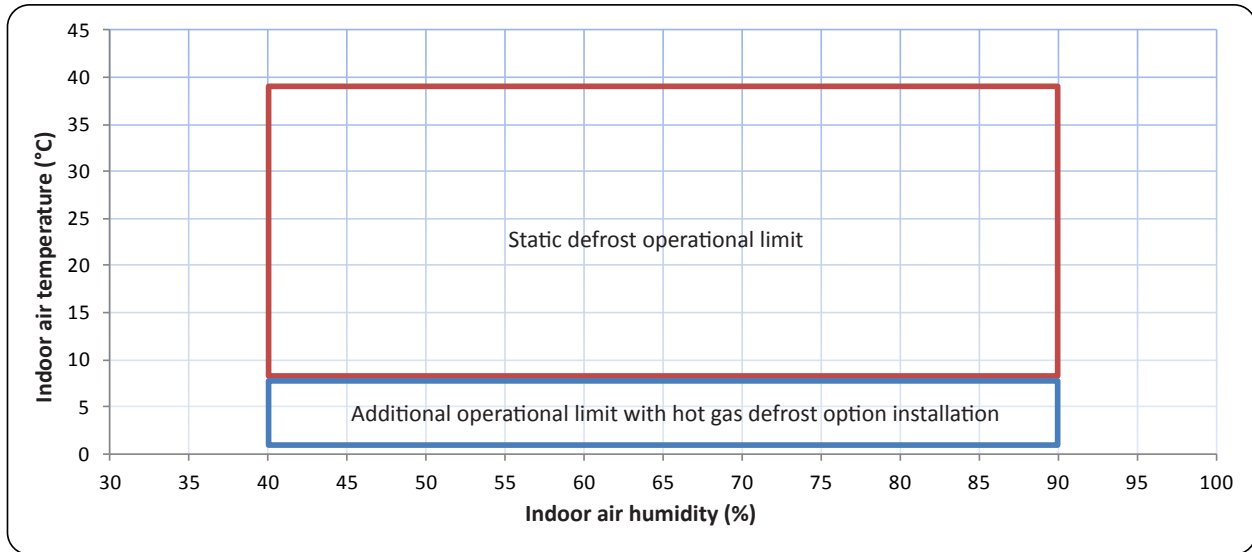

*The graph refers to the values read at the evaporating coil inlet.*

### 2.5.2 SP - ST

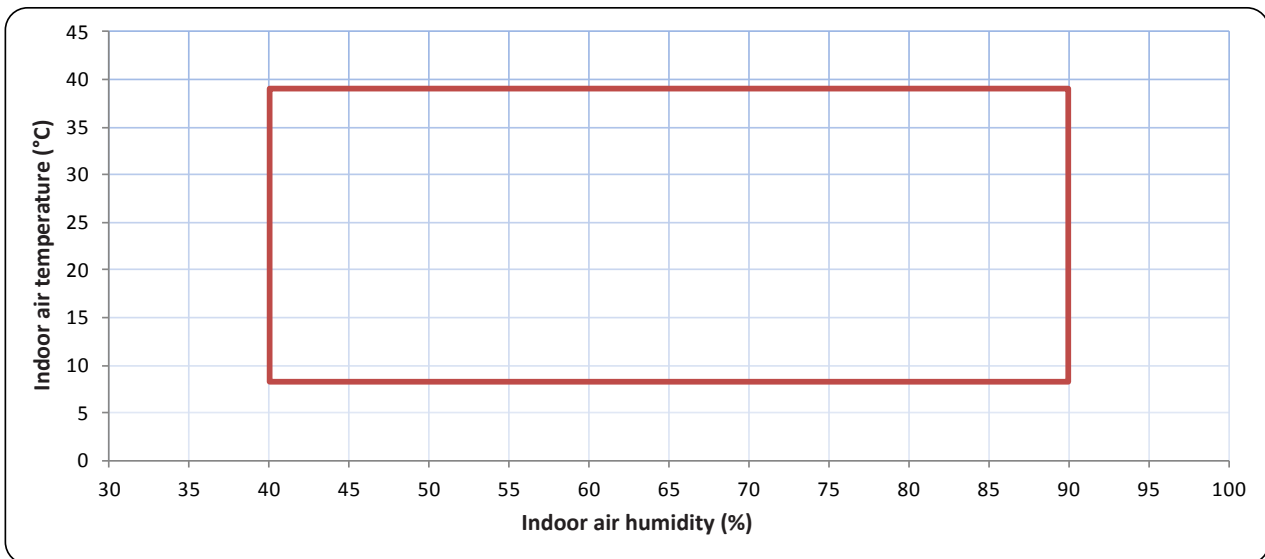

## 2.6 ELECTRIC CIRCUITS

The electric panel is built and wired in accordance with standard EN 60204-1. The control panel is protected by a magneto-thermic switch. All the remote controls work with low voltage signals, powered by an isolation transformer.



*Do not disconnect the unit using the protection upstream of the unit; this device must be used only to disconnect the unit for maintenance. To switch off, use the user terminal.*

## 2.7 REFRIGERATING AND HYDRAULIC CIRCUITS

All copper pipes are made to our specifications in order to maintain complete control over the construction process and implicitly improve the quality of our products. Every pipe meets the requirements laid down by Pressure Equipment Directive 97/23/EC and is checked by the FEM calculation method at the point of maximum stress on a 180° bend and the maximum pressure allowed by safety standards, taking into account appropriate safety coefficients.

All units install a stainless steel condensate tray below the coils.

### 3 BASIC USER TERMINAL

It controls all the functions and devices of the unit. Dehumidification is activated by an external hygostat.

The compressor has a 5-minute delayed start or re-start setting to avoid any mechanical damage to inner parts. If the compressor does not start, wait a few minutes.

Any error or problem is displayed on the screen based on the troubleshooting table shown below.

By default, the fan is always on and does not depend on the compressor starting. This factory setting can be changed. Please refer to the installation section.

#### 3.1 KEYS AND DISPLAY



#### UP ( ▲ )

Increases the values/scrolls up the parameters; turns off an acoustic alarm if present.

#### DOWN ( ▼ )

Decreases the values/scrolls down the parameters.

#### STAND-BY

Turns the unit on and off. At start-up, an acoustic alarm is given.

#### SET

Allow to set the parameters.

#### 5 Temperature values or parameters

#### 6 Compressor icon

OFF = compressor off  
ON = compressor on  
FLASHING = compressor off, in stand-by

#### 7 Heating icon

OFF = heating off  
ON = heating on



### 8 Defrost icon

OFF = defrost off  
ON = defrost on

### 9 Ventilation icon

OFF = ventilation off  
ON = ventilation on

### 10 Dehumidification request icon

ON = digital input on  
FLASHING = digital input off

### 11 Alarm present icon

OFF = no alarm present  
FLASHING = alarm present

## 3.2 MAIN COMMANDS

### 3.2.1 Switching on and off

The unit status is shown on the display, either ON or OFF  
To switch it on or off, press the STAND-BY key.

### 3.2.2 Setting the desired temperature

The IT and ST units can heat and cool.

The ID and SP units with electric coils or post-heating water coils can heat.

In these cases, a required temperature value is set on the control unit which can be changed as follows:

- Hold down the UP (▲) and DOWN (▼) keys for 3 seconds to enter the user menu
- Use the UP (▲) and DOWN (▼) keys to go to *SEc*
- Hold down the SET key to display the temperature; press the UP (▲) and DOWN (▼) keys to modify the setting and release the SET key to exit edit mode.
- Hold down the UP (▲) and DOWN (▼) keys for 3 seconds to exit the menu

## 3.3 USER MENU

In the user menu, it is possible to read the temperature probes, change the required temperature and read the software release.

To access the user menu:

- Hold down the UP (▲) and DOWN (▼) keys for 3 seconds. When you enter the menu, there is an audible beep.
- Use the UP (▲) and DOWN (▼) keys to select the variable to view or modify
- You can now modify the value by holding down the SET key and pressing the UP (▲) or DOWN (▼) key.
- To exit the menu, hold down the UP (▲) and DOWN (▼) keys for 3 seconds or wait 30 seconds without pressing any keys. You will hear a beep to confirm.

<i>NAME</i>	<i>DESCRIPTION</i>	<i>DEFAULT</i>
<i>SEc</i>	Setting the desired temperature	26.0 °C
<i>tAc</i>	Air temperature reading	Reading
<i>tEu</i>	Defrost temperature reading	Reading
<i>rEL</i>	Software release	Reading

## 3.4 OTHER FUNCTIONS

### 3.4.1 Manual defrost activation

If the temperature reading on the defrost sensor is below 5°C, defrosting could be activated manually by holding down key ▼ for 3 seconds which will be confirmed by an acoustic signal.

### 3.4.2 Forced manual defrost termination

During defrosting, press (▼) key for 3 seconds to abort defrosting which will be confirmed by an acoustic signal.  
This function cannot be activated from the programming menu.

## 4 ADVANCED USER TERMINAL

All the software for managing and optimising the refrigerating circuit, the electronic and electro-mechanical components is implemented and developed in-house by a highly specialised team.

The following functions are available:

- ON/OFF unit,
- ON/OFF dehumidify,
- setting humidity value (set humidity),
- setting required temperature value (set temperature) [optional],
- alarm display and incorrect phase sequence display,
- reading of all sensors,
- display of components status,
- time band control [optional]
- season selection: summer and winter [optional],
- display of clogged filters [optional]

### 4.1 USE OF KEYS



#### ↑ ↓ ARROW KEYS

To scroll the pages or change the selected value.

#### PRG KEY

To access the display page and change the advanced parameters.  
A password must be entered.

#### ESC KEY

To exit without changing a value or go back to the previous page.

#### ENTER ↵ KEY

To turn the unit on or off from the home page.  
In the other pages, it allows you to enter and change a value or to confirm the change and go back to scrolling.

#### ALARM KEY

The ALARM button turns red if there is an alarm.

It allows you to access the alarm page:

- if there are no active alarms, it will display: no alarm present;
- if one or more alarms are active, a page will be displayed for each active alarm.



**ATTENZIONE  
WARNING**

*The images and illustrations on the following pages may all differ depending on the unit purchased, the options installed and any software changes implemented after this document has been published.*

4.2 MAIN PAGE

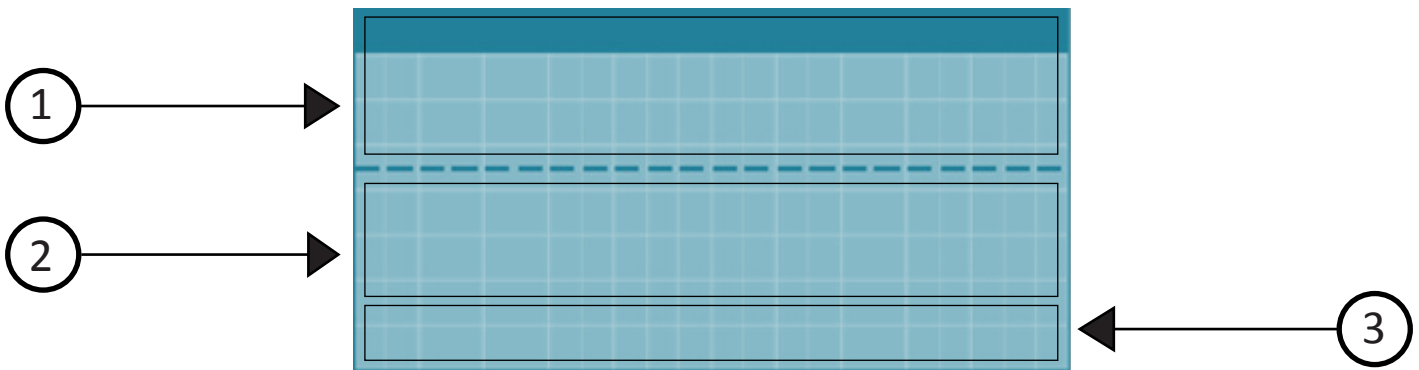

- 1 Indication of dehumidifier status:
- unit ON
  - unit OFF by display
  - unit OFF by contact (switched off remotely)
  - unit OFF by time bands
  - unit OFF by serial (switched off remotely)

- 2 Information on the current operational state of the unit:
- *unit starting: unit start-up procedure*
  - *ventilation: the compressor is idle and the unit is in ventilation mode only*
  - *dehumidification: the unit is in dehumidification and is working regularly*
  - *compressor shutdown for \_\_: there is a fault in the refrigerating circuit, refer to the section on malfunctions and faults*

- 3 Indication of one of the following faults (refer to the section on malfunctions and faults):
- *dirty filters: the air filter is dirty or clogged*
  - *fault probe \_\_: fault of a probe in the unit*
  - *phase sequence error: the phases are inverted or a power phase is missing*

4.3 OTHER USER PAGES

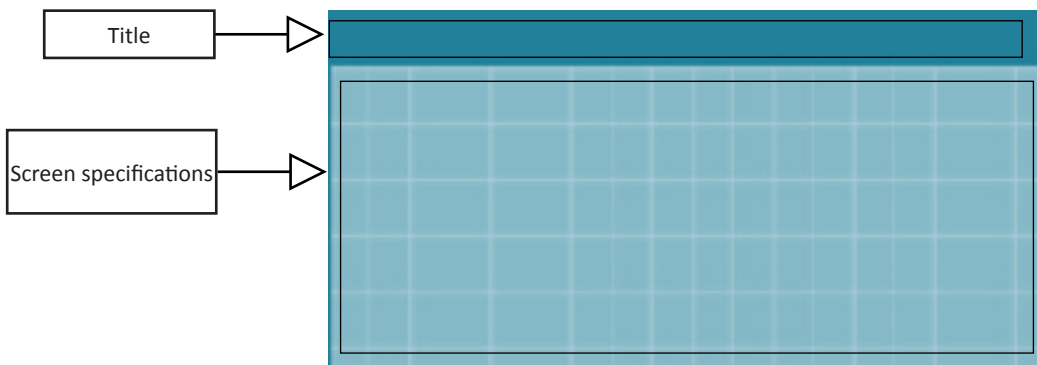

Use of keys during navigation between pages:

- press the **↑ ↓** keys to scroll through the pages
- press the **Esc** key to return to the home page

- Every single page is explained below:
- unit status
  - sensors
  - adjustments
  - clock/time bands
  - flow rate
  - software info

## 4.4 USER MENU PAGES

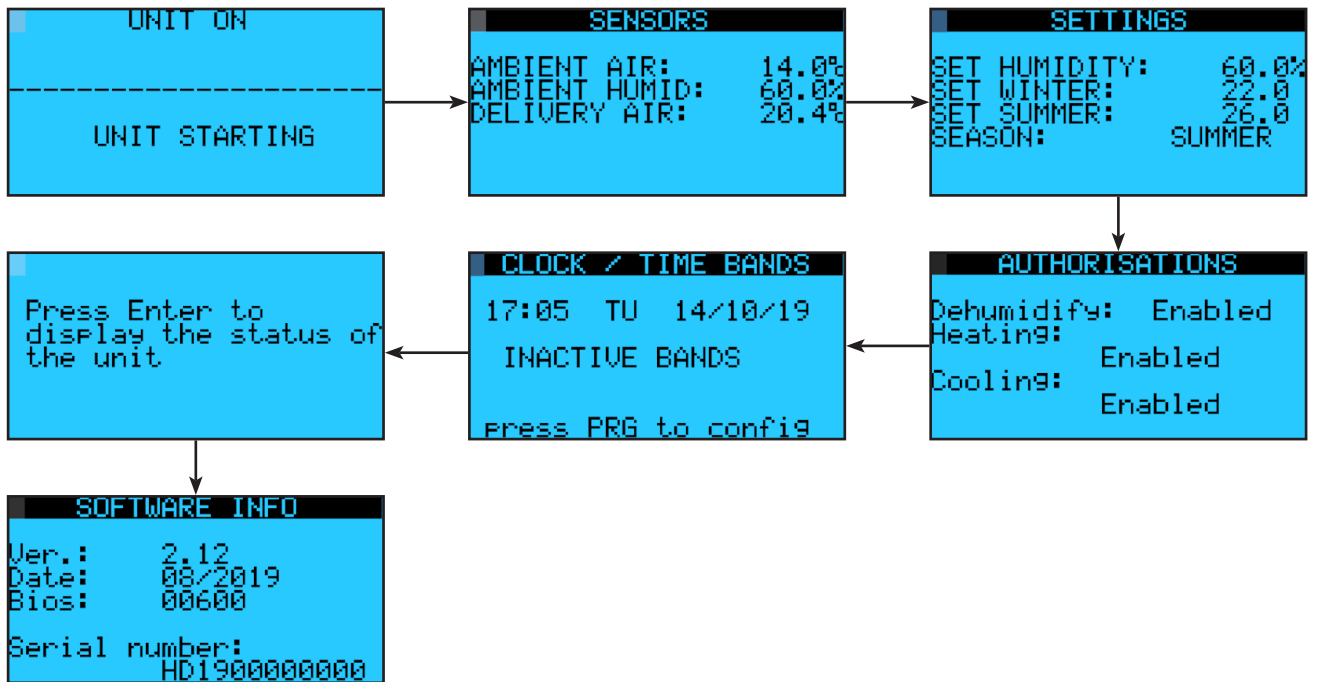

### USE OF THE KEYS DURING PAGES BROWSING

- use the ↑ ↓ keys to scroll through the lines
- press **Enter** ↵ to access the highlighted menu
- press the **Esc** key to return to the password request page

### USE OF KEYS DURING PARAMETERS MODIFICATION

- press key **Enter** ↵ to modify; fist value will flash
- press keys ↑ ↓ to modify parameter value
- press key **Enter** ↵ to confirm and go to next parameter
- press key **Esc** to come back to the main screen



### 4.4.1 Switching ON and OFF

In the main screen press **Enter** ↵ to switch on or off the unit

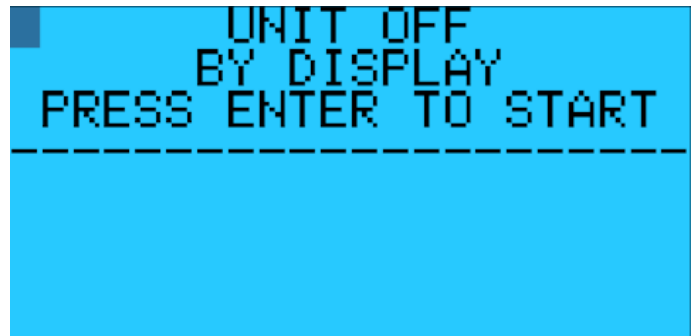
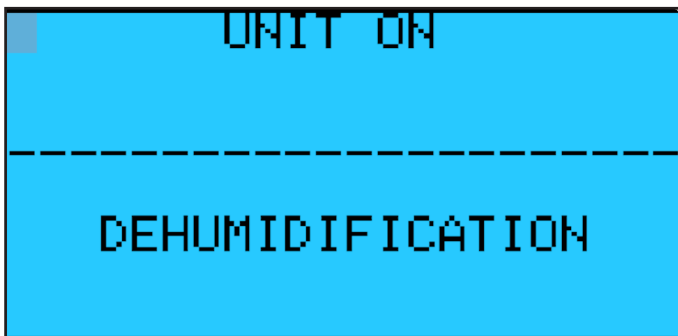

### 4.4.2 Sensors



Only visualization page, it allows to read probe value.

#### 4.4.3 Settings

It is possible to choose (*installer menu*) between two temperature set: “Single set” or “Seasonal set”.

With “Single set” the screen will be A, with “Seasonal set” the screen

“Seasonal set” is active (and it is not settable “single set”) with chilled water coil and function “Cooling and heating”.

If “Seasonal set” is chosen, but temperature control options are not present none operation will be performed.

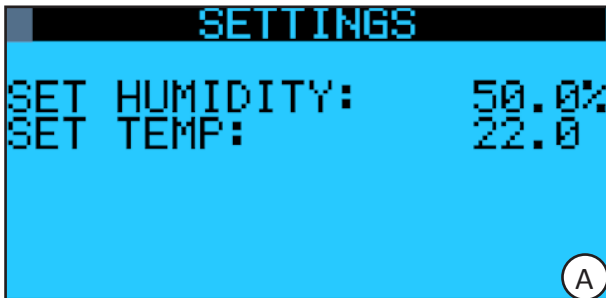

**Set humidity:** modify required humidity

**Set temp:** modify required temperature

**Set humidity:** modify required humidity

**Temp winter:** modify required temperature with winter season

**Temp summer:** modify required temperature with summer season

**Season:** it is possible to choose season between

- Summer
- Winter

#### 4.4.4 Authorisations

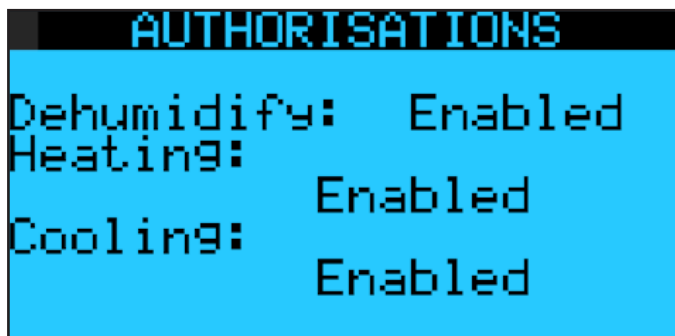

This page allows to enable air treatment and free cooling/heating.

Parameters “Heating” e “Cooling” are shown only if hot/cold water coil is present.

#### 4.4.5 Clock/Time bands

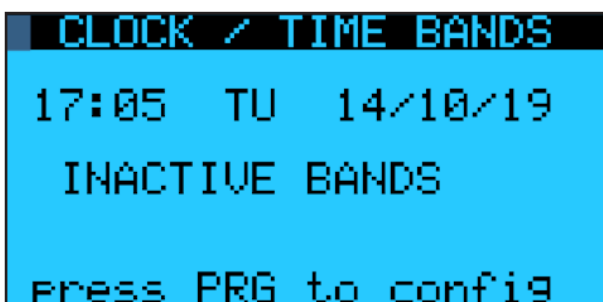

Page is active only if it is present option “Clock card with time bands”

To set time bands refers to “Time bands setting” paragraph in the following pages.

#### 4.4.6 Unit status

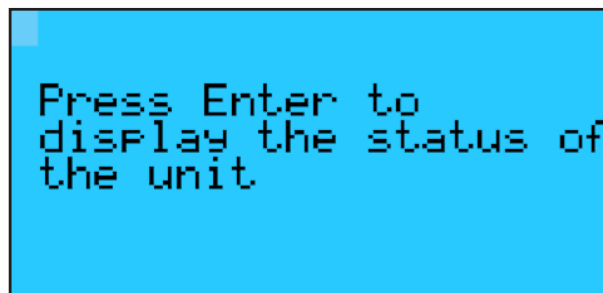

Unit status page shows unit information, as temperature, pressure and component status.

Pressing key **Enter** ↵, it will shown details pages (following images).

### 4.4.7 Unit Status - details

Only visualization pages. Some pages and parameters are shown depending on options and unit model.

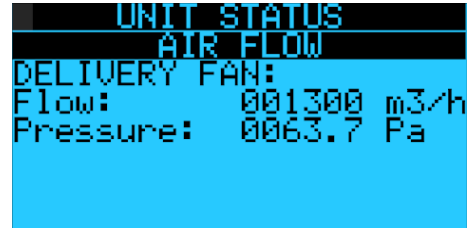
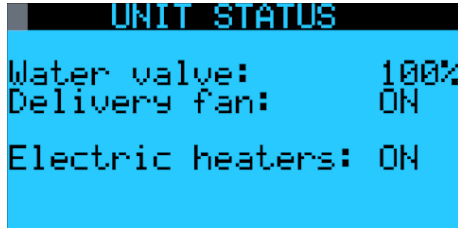
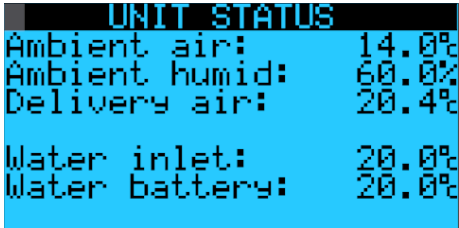

**Water inlet:** inlet coil water temperature

**Water battery:** outlet coil water temperature

Following pages are shown depending on unit version, furthermore from model 1100 two pages are shown “Status Circuit 1” and “Status Circuit 2” for the two refrigerating circuits.

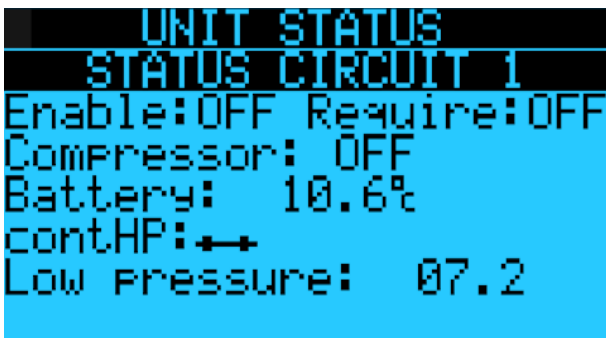

#### IT / ST unit

These units install a pressure transducer on the low pressure side, the measured pressure is shown as “**Low pressure**”.

**contHP:** high pressure switch, if shown open contact, the pressure switch is open.

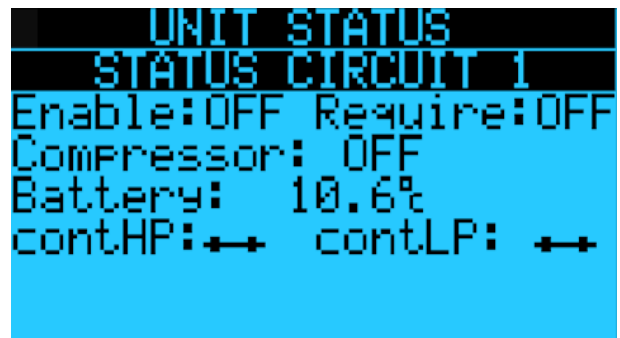

#### ID / SP unit

**contHP:** high pressure switch, if shown open contact, the pressure switch is open.

**contLP:** low pressure switch, if shown open contact, the pressure switch is open.

### 4.4.8 Software Info

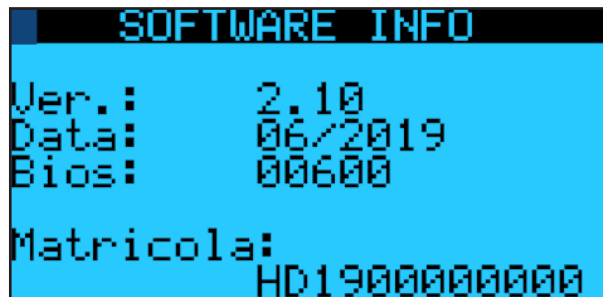

Questa pagina indica la versione e data di rilascio del software dell’unità e la matricola della stessa.

## 4.5 TIME BAND SETTINGS

From the home page, with the ↑ ↓ keys, scroll through the pages and go to the CLOCK/TIME BANDS page

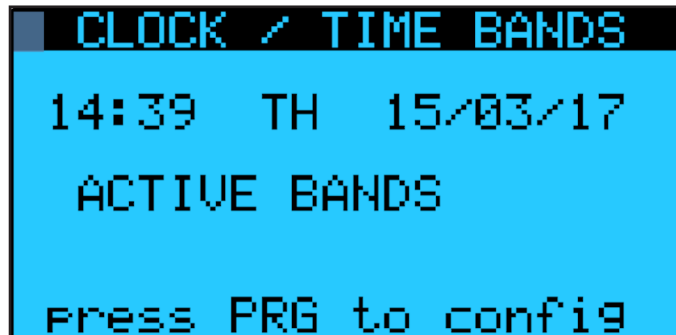

Press **Prg**



In the settings page it is possible to set the time and then configure the time bands.  
Both settings are shown below

### 4.5.1 Adjusting date and time

With ↑ ↓ keys, move to ADJUST TIME and press **Enter** ↵

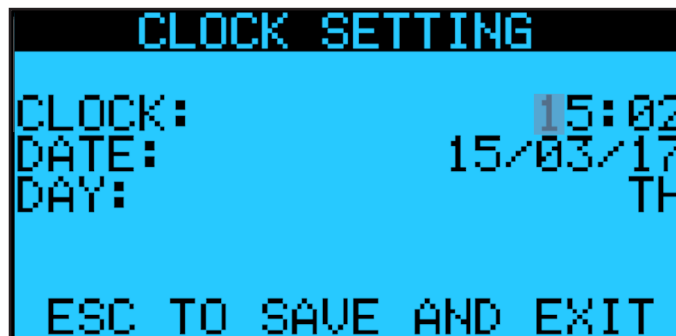

**AVVERTENZA**  
**CAUTION**

*Use of keys:*

- with the ↑ ↓ keys, you can change the flashing value
- press the **Enter** ↵ key to move to the next value
- press the **Esc** key to exit and return to the previous page

## 4.5.2 Adjusting time bands

Control manages the time bands in 2 programs: weekdays and weekends.  
 Each program allows to manage the settings for on/off, temperature and humidity.  
 Once modification of two programs is done, it is necessary to assign a program to each day of the week.

With the **↑ ↓**, move to ADJUST TIME and press **Enter ↵**



*Use of the keys during navigation*

- use the **↑ ↓** keys to scroll through the pages.
- press the **Enter ↵** key to edit the settings and the first value flashes
- press the **Esc** key to return to the home page



*Use of the keys during modification*

- use the **↑ ↓** keys to change the value that is flashing
- when you press the **Enter ↵** key, the next value flashes or if it is the last value, you return to the navigation page
- press the **Esc** key to return to the navigation page

WORKING PROGRAM		
	TIME	BANDS
BAND 1:	00:00	04:00
BAND 2:	04:00	08:00
BAND 3:	08:00	12:00
BAND 4:	12:00	16:00
BAND 5:	16:00	20:00
BAND 6:	20:00	23:59

First page: set the duration of each single time band for the weekday program.

WORKING PROGRAM		
	UNIT	ON/OFF
BAND 1:		ON
BAND 2:		ON
BAND 3:		ON
BAND 4:		ON
BAND 5:		ON
BAND 6:		ON

Second page: set unit on/off for each time band

WORKING PROGRAM		
	HUMIDITY	
BAND 1:	60%	
BAND 2:	60%	
BAND 3:	60%	
BAND 4:	60%	
BAND 5:	60%	
BAND 6:	60%	

Third page: set the humidity set point for each time band





Fourth page: set temperature setpoint for each time band  
*This page is shown only if it is present a control temperature option.*

Following there are the pages of the holiday program, that are similar to the weekday program.

Last page of the menu “Time bands” allows to assign weekday and holiday program to each day of the week.



At the end of the time bands setting exit pressing key Esc

#### 4.5.3 Time bands enabling



*Time bands enabling is not automatic.  
Remember to enable time bands, follow the procedure below.*

On the main menu with keys ↑ ↓ scroll through the pages and search the page CLOCK/TIME BANDS.

Press key **Enter** ↵, the cursor is positioned on ACTIVE BANDS.

With keys ↑ ↓ select “Active bands” or “Inactive bands” depending on the desired operation.

To exit and confirm the modification press key **Esc**.

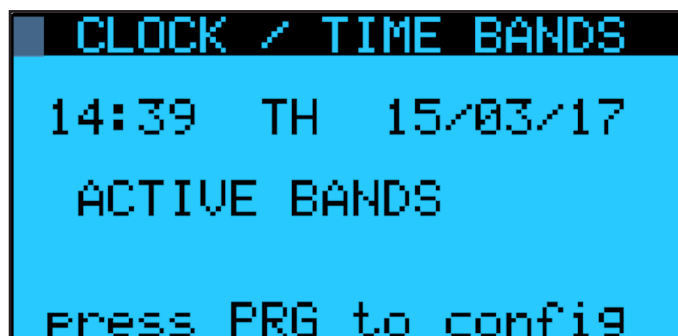

## 5 TECHNICAL DATA

### 5.1 TECHNICAL DATA TABLE

#### 5.1.1 Frame 2

	Model	um	100	130	160	190
Refrigerating Circuits	Compressor	type	rotary	rotary	rotary	scroll
	Refrigerating circuits	no.	1	1	1	1
	Refrigerant	type	R410A	R410A	R410A	R410A
Thermodin. performance	Dehumidification capacity	L/24h	100	128	157	190
	Cooling capacity (IT - ST only)	kW	4,9	6,5	8	10
Electrical Data	Compressor power	kW	1,55	1,6	2,1	3,5
	Compressor current	A	7,0	7,2	9,7	16,8
	Absorbed power (standard centrifugal fans)	kW	1,8	1,96	2,5	3,9
	Absorbed current (standard centrifugal fans)	A	7,9	8,7	12	19
	Absorbed power (high pressure centrifugal fans)	kW	1,8	1,9	2,4	3,8
	Absorbed current (high pressure centrifugal fans)	A	8,1	8,5	11	19
	Absorbed power (radial fans)	kW	1,6	1,7	2,3	3,7
	Absorbed current (radial fans)	A	7,4	7,8	11	18
	Maximum absorbed power	kW	2,5	2,6	3,7	5,4
	Maximum absorbed current	A	11,4	11,7	17	25
	Inrush current	A	39	39	65	100
Power supply	V/Ph/Hz	230 / 1~ + N / 50				
Hot Water Coil	Heating capacity hot water coil	kW	5,5	9,8	9,8	9,8
	Nominal flow hot water coil	m <sup>3</sup> /h	0,47	0,84	0,84	0,84
	Hot water coil pressure drop	kPa	12	38	38	38
Aeraulic Data	Supply fans	no.	1	1	1	1
	Recirculation airflow	m <sup>3</sup> /h	900	1200	1600	1600
	Useful static pressure (standard centrifugal fans)	Pa	50	50	50	50
	Useful static pressure (high pressure centrifugal fans)	Pa	100	100	130	130
	Useful static pressure (radial fans)	Pa	450	450	400	400
Desuperheater	Desuperheater heating capacity	kW	1,7	2	2,5	2,8
	Desuperheater water flow rate	m <sup>3</sup> /h	0,30	0,35	0,43	0,48
General Data	Dimensions (base x depth x height)	mm	700 x 550 x 900			
	Weight	kg	100	100	105	110
	Sound pressure level	db (A)	56	56	60	61
External unit (IT- ST only)	Maximum power	kW	0,18	0,18	0,18	0,18
	Maximum current	A	0,81	0,81	0,81	0,81
	Power supply	V/Ph/Hz	230 / 1~ + N / 50			
	Dimensions (base x depth x height)	mm	748 x 404 x 575			
	Weight	kg	24	24	24	24
	Sound pressure level	db (A)	49	49	49	49

Dehumidification capacity, cooling capacity, currents and electrical power are declared with ambient air at 30°C/80% RH, nominal flow rate + 50 Pa available; for IT and ST models with external air at 30°C/50% RH.

1. Heating capacity of the hot water coil is declared with water in at 80°C and out at 70°C, air 30°C and nominal flow rate.
2. Water pressure drops are declared at nominal water flow rate
3. Static pressure available is declared at the nominal air flow rate
4. Sound pressure level is measured in free field at distance of 1 m from the unit

## 5.1.2 Frame 3

	Model	um	210	260	300
Refrigerating Circuits	Compressor	type	scroll	scroll	scroll
	Refrigerating circuits	no.	1	1	1
	Refrigerant	type	R410A	R410A	R410A
Thermodin. performance	Dehumidification capacity	L/24h	210	268	302
	Cooling capacity (IT - ST only)	kW	11	15	16
Electrical Data	Compressor power	kW	3,2	4,1	4,2
	Compressor current	A	6,1	7,4	7,6
	Absorbed power (standard centrifugal fans)	kW	3,7	4,8	5,0
	Absorbed current (standard centrifugal fans)	A	8	10	11
	Absorbed power (high pressure centrifugal fans)	kW	3,6	4,8	5,0
	Absorbed current (high pressure centrifugal fans)	A	8	10	11
	Absorbed power (radial fans)	kW	3,5	4,6	4,7
	Absorbed current (radial fans)	A	7	8	9
	Maximum absorbed power	kW	5,5	6,8	7
	Maximum absorbed current	A	10	14	15
	Inrush current	A	51	68	68
	Power supply	V/Ph/Hz	400 / 3~ + N / 50		
Hot Water Coil	Heating capacity hot water coil	kW	16,5	17	17
	Nominal flow hot water coil	m <sup>3</sup> /h	1,42	1,46	1,46
	Hot water coil pressure drop	kPa	30	31	31
Aeraulic Data	Supply fans	no.	1	1	1
	Recirculation airflow	m <sup>3</sup> /h	2000	2800	2800
	Useful static pressure (standard centrifugal fans)	Pa	50	50	50
	Useful static pressure (high pressure centrifugal fans)	Pa	100	100	100
	Useful static pressure (radial fans)	Pa	550	350	350
Desuperheater	Desuperheater heating capacity	kW	2,9	4,6	4,8
	Desuperheater water flow rate	m <sup>3</sup> /h	0,5	0,8	0,8
General Data	Dimensions (base x depth x height)	mm	700 x 850 x 900		
	Weight	kg	120	130	140
	Sound pressure level	db (A)	62	62	63
External unit (IT- ST only)	Maximum power	kW	0,36	0,36	0,36
	Maximum current	A	1,62	1,62	1,62
	Power supply	V/Ph/Hz	230 / 1~ + N / 50		
	Dimensions (base x depth x height)	mm	1303 x 404 x 575		
	Weight	kg	34	34	34
	Sound pressure level	db (A)	52	52	52

Dehumidification capacity, cooling capacity, currents and electrical power are declared with ambient air at 30°C/80% RH, nominal flow rate + 50 Pa available; for IT and ST models with external air at 30°C/50% RH.

1. Heating capacity of the hot water coil is declared with water in at 80°C and out at 70°C, air 30°C and nominal flow rate.
2. Water pressure drops are declared at nominal water flow rate
3. Static pressure available is declared at the nominal air flow rate
4. Sound pressure level is measured in free field at distance of 1 m from the unit

### 5.1.3 Frame 4

	Model	um	350	450	580
Refrigerating Circuits	Compressor	type	scroll	scroll	scroll
	Refrigerating circuits	no.	1	1	1
	Refrigerant	type	R410A	R410A	R410A
Thermodin. performance	Dehumidification capacity	L/24h	358	452	581
	Cooling capacity (IT - ST only)	kW	19	23	30
Electrical Data	Compressor power	kW	4,3	5,1	7,7
	Compressor current	A	7,6	9	13,7
	Absorbed power (standard centrifugal fans)	kW	5,2	6,1	8,9
	Absorbed current (standard centrifugal fans)	A	12	14	19
	Absorbed power (high pressure centrifugal fans)	kW	4,8	6,0	8,9
	Absorbed current (high pressure centrifugal fans)	A	10	13	20
	Absorbed power (radial fans)	kW	4,6	5,5	8,3
	Absorbed current (radial fans)	A	8	10	15
	Maximum absorbed power	kW	8,6	10,2	13,4
	Maximum absorbed current	A	16	19	25
	Inrush current	A	69	72	102
	Power supply	V/Ph/Hz	400 / 3~ + N / 50		
Hot Water Coil	Heating capacity hot water coil	kW	26,5	26,5	27
	Nominal flow hot water coil	m <sup>3</sup> /h	2,28	2,28	2,32
	Hot water coil pressure drop	kPa	40	40	40
Aeraulic Data	Supply fans	no.	1	1	1
	Recirculation airflow	m <sup>3</sup> /h	3800	4000	4800
	Useful static pressure (standard centrifugal fans)	Pa	50	50	50
	Useful static pressure (high pressure centrifugal fans)	Pa	130	110	130
	Useful static pressure (radial fans)	Pa	550	540	450
Desuperheater	Desuperheater heating capacity	kW	4,3	5,8	8,1
	Desuperheater water flow rate	m <sup>3</sup> /h	0,7	1	1,4
General Data	Dimensions (base x depth x height)	mm	830 x 850 x 1350		
	Weight	kg	220	230	240
	Sound pressure level	db (A)	64	65	65
External unit (IT - ST only)	Maximum power	kW	0,36	0,54	0,54
	Maximum current	A	1,62	2,43	2,43
	Power supply	V/Ph/Hz	230 / 1~ + N / 50		
	Dimensions (base x depth x height)	mm	1303 x 404 x 575	1858 x 404 x 575	
	Weight	kg	42	58	64
	Sound pressure level	db (A)	52	54	54

Dehumidification capacity, cooling capacity, currents and electrical power are declared with ambient air at 30°C/80% RH, nominal flow rate + 50 Pa available; for IT and ST models with external air at 30°C/50% RH.

1. Heating capacity of the hot water coil is declared with water in at 80°C and out at 70°C, air 30°C and nominal flow rate.
2. Water pressure drops are declared at nominal water flow rate
3. Static pressure available is declared at the nominal air flow rate
4. Sound pressure level is measured in free field at distance of 1 m from the unit

## 5.1.4 Frame 5

	Model	um	750	950
<b>Refrigerating Circuits</b>	<b>Compressor</b>	type	scroll	scroll
	<b>Refrigerating circuits</b>	no.	1	1
	<b>Refrigerant</b>	type	R410A	R410A
<b>Thermodin. performance</b>	<b>Dehumidification capacity</b>	L/24h	760	955
	<b>Cooling capacity (IT - ST only)</b>	kW	38	50
<b>Electrical Data</b>	<b>Compressor power</b>	kW	9	11,6
	<b>Compressor current</b>	A	17	22
	<b>Absorbed power (standard centrifugal fans)</b>	kW	10	13
	<b>Absorbed current (standard centrifugal fans)</b>	A	19	25
	<b>Absorbed power (high pressure centrifugal fans)</b>	kW	10,6	13,5
	<b>Absorbed current (high pressure centrifugal fans)</b>	A	22	28
	<b>Absorbed power (radial fans)</b>	kW	9,9	12,9
	<b>Absorbed current (radial fans)</b>	A	18	24
	<b>Maximum absorbed power</b>	kW	16,3	20
	<b>Maximum absorbed current</b>	A	30	36
	<b>Inrush current</b>	A	153	203
	<b>Power supply</b>	V/Ph/Hz	400 / 3~ + N / 50	
<b>Hot Water Coil</b>	<b>Heating capacity hot water coil</b>	kW	48	55
	<b>Nominal flow hot water coil</b>	m <sup>3</sup> /h	4,13	4,73
	<b>Hot water coil pressure drop</b>	kPa	36	38
<b>Aeraulic Data</b>	<b>Supply fans</b>	no.	1	1
	<b>Recirculation airflow</b>	m <sup>3</sup> /h	7000	8200
	<b>Useful static pressure (standard centrifugal fans)</b>	Pa	130	130
	<b>Useful static pressure (high pressure centrifugal fans)</b>	Pa	250	250
	<b>Useful static pressure (radial fans)</b>	Pa	450	400
<b>Desuperheater</b>	<b>Desuperheater heating capacity</b>	kW	11,5	14,5
	<b>Desuperheater water flow rate</b>	m <sup>3</sup> /h	2	2,5
<b>General Data</b>	<b>Dimensions (base x depth x height)</b>	mm	1000 x 1400 x 1350	
	<b>Weight</b>	kg	410	430
	<b>Sound pressure level</b>	db (A)	66	66
<b>External unit (IT - ST only)</b>	<b>Maximum power</b>	kW	1,08	1,08
	<b>Maximum current</b>	A	6,48	6,48
	<b>Power supply</b>	V/Ph/Hz	230 / 1~ + N / 50	
	<b>Dimensions (base x depth x height)</b>	mm	1858 x 404 x 1130	
	<b>Weight</b>	kg	102	128
	<b>Sound pressure level</b>	db (A)	57	57

Dehumidification capacity, cooling capacity, currents and electrical power are declared with ambient air at 30°C/80% RH, nominal flow rate + 50 Pa available; for IT and ST models with external air at 30°C/50% RH.

1. Heating capacity of the hot water coil is declared with water in at 80°C and out at 70°C, air 30°C and nominal flow rate.
2. Water pressure drops are declared at nominal water flow rate
3. Static pressure available is declared at the nominal air flow rate
4. Sound pressure level is measured in free field at distance of 1 m from the unit

5.1.5 Frame 6

	Model	um	1100	1400
<b>Refrigerating Circuits</b>	<b>Compressor</b>	type	scroll	scroll
	<b>Refrigerating circuits</b>	no.	2	2
	<b>Refrigerant</b>	type	R410A	R410A
<b>Thermodin. performance</b>	<b>Dehumidification capacity</b>	L/24h	1120	1350
	<b>Cooling capacity (IT - ST only)</b>	kW	56	66
<b>Electrical Data</b>	<b>Compressor power</b>	kW	6	7,2
	<b>Compressor current</b>	A	11,4	14,3
	<b>Absorbed power (standard centrifugal fans)</b>	kW	14	16,8
	<b>Absorbed current (standard centrifugal fans)</b>	A	26	33
	<b>Absorbed power (high pressure centrifugal fans)</b>	kW	15	18
	<b>Absorbed current (high pressure centrifugal fans)</b>	A	31	38
	<b>Absorbed power (radial fans)</b>	kW	13	16
	<b>Absorbed current (radial fans)</b>	A	25	31
	<b>Maximum absorbed power</b>	kW	23	26,6
	<b>Maximum absorbed current</b>	A	44	50
	<b>Inrush current</b>	A	126	173
	<b>Power supply</b>	V/Ph/Hz	400 / 3~ + N / 50	
<b>Hot Water Coil</b>	<b>Heating capacity hot water coil</b>	kW	76	83
	<b>Nominal flow hot water coil</b>	m <sup>3</sup> /h	6,54	7,14
	<b>Hot water coil pressure drop</b>	kPa	55	58
<b>Aeraulic Data</b>	<b>Supply fans</b>	no.	2	2
	<b>Recirculation airflow</b>	m <sup>3</sup> /h	11000	12500
	<b>Useful static pressure (standard centrifugal fans)</b>	Pa	200	200
	<b>Useful static pressure (high pressure centrifugal fans)</b>	Pa	300	300
	<b>Useful static pressure (radial fans)</b>	Pa	480	450
<b>Desuperheater</b>	<b>Desuperheater heating capacity</b>	kW	14	18
	<b>Desuperheater water flow rate</b>	m <sup>3</sup> /h	2,4	3,1
<b>General Data</b>	<b>Dimensions (base x depth x height)</b>	mm	1000 x 1950 x 1640	
	<b>Weight</b>	kg	650	720
	<b>Sound pressure level</b>	db (A)	68	69
<b>External unit (IT- ST only)</b>	<b>Maximum power</b>	kW	1,44	1,44
	<b>Maximum current</b>	A	6,48	6,48
	<b>Power supply</b>	V/Ph/Hz	230 / 1~ + N / 50	
	<b>Dimensions (base x depth x height)</b>	mm	2413 x 404 x 1130	
	<b>Weight</b>	kg	147	147
	<b>Sound pressure level</b>	db (A)	59	59

Dehumidification capacity, cooling capacity, currents and electrical power are declared with ambient air at 30°C/80% RH, nominal flow rate + 50 Pa available; for IT and ST models with external air at 30°C/50% RH.

1. Heating capacity of the hot water coil is declared with water in at 80°C and out at 70°C, air 30°C and nominal flow rate.
2. Water pressure drops are declared at nominal water flow rate
3. Static pressure available is declared at the nominal air flow rate
4. Sound pressure level is measured in free field at distance of 1 m from the unit

## 5.1.6 Frame 7

	Model	um	1500	1700	1900	2200
Refrigerating Circuits	Compressor	type	scroll	scroll	scroll	scroll
	Refrigerating circuits	no.	2	2	2	2
	Refrigerant	type	R410A	R410A	R410A	R410A
Thermodin. performance	Dehumidification capacity	L/24h	1480	1710	1870	2180
	Cooling capacity (IT - ST only)	kW	75	86	96	110
Electrical Data	Compressor power	kW	7,9	9	10	11,6
	Compressor current	A	15	17	17,8	22
	Absorbed power (standard centrifugal fans)	kW	18	21	23	27
	Absorbed current (standard centrifugal fans)	A	34	39	41	50
	Absorbed power (high pressure centrifugal fans)	kW	19	22	24	28
	Absorbed current (high pressure centrifugal fans)	A	40	45	47	57
	Absorbed power (radial fans)	kW	17	20	22	25
	Absorbed current (radial fans)	A	32	36	38	47
	Maximum absorbed power	kW	29	35	39	43
	Maximum absorbed current	A	53	59	63	72
	Inrush current	A	175	183	196	239
	Power supply	V/Ph/Hz	400 / 3~ + N / 50			
Hot Water Coil	Heating capacity hot water coil	kW	98	107	107	118
	Nominal flow hot water coil	m <sup>3</sup> /h	8,43	9,2	9,2	10,15
	Hot water coil pressure drop	kPa	60	63	63	68
Aeraulic Data	Supply fans	no.	2	2 / 3	2 / 3	2 / 3
	Recirculation airflow	m <sup>3</sup> /h	13000	15000	15000	17000
	Useful static pressure (standard centrifugal fans)	Pa	200	200	200	200
	Useful static pressure (high pressure centrifugal fans)	Pa	300	300	300	300
	Useful static pressure (radial fans)	Pa	450	480	480	450
Desuperheater	Desuperheater heating capacity	kW	19	22	25	29
	Desuperheater water flow rate	m <sup>3</sup> /h	3,2	3,8	4,3	5
General Data	Dimensions (base x depth x height)	mm	1000 x 2500 x 1640			
	Weight	kg	780	840	900	950
	Sound pressure level	db (A)	70	71	71	72
External unit (IT-ST only)	Maximum power	kW	3,88	3,88	3,88	3,88
	Maximum current	A	7,8	7,8	7,8	7,8
	Power supply	V/Ph/Hz	400 / 3~ + N / 50			
	Dimensions (base x depth x height)	mm	3800 x 1100 x 1144			
	Weight	kg	332	332	332	332
	Sound pressure level	db (A)	61	61	61	61

Dehumidification capacity, cooling capacity, currents and electrical power are declared with ambient air at 30°C/80% RH, nominal flow rate + 50 Pa available; for IT and ST models with external air at 30°C/50% RH.

1. Heating capacity of the hot water coil is declared with water in at 80°C and out at 70°C, air 30°C and nominal flow rate.
2. Water pressure drops are declared at nominal water flow rate
3. Static pressure available is declared at the nominal air flow rate
4. Sound pressure level is measured in free field at distance of 1 m from the unit

5.1.7 Frame 8 and 9

	Model	um	3000	4500
<b>Refrigerating Circuits</b>	<b>Compressor</b>	type	scroll	scroll
	<b>Refrigerating circuits</b>	no.	2	2
	<b>Refrigerant</b>	type	R410A	R410A
<b>Thermodin. performance</b>	<b>Dehumidification capacity</b>	L/24h	2960	4650
	<b>Cooling capacity (IT - ST only)</b>	kW	148	277
<b>Electrical Data</b>	<b>Compressor power</b>	kW	15,1	26,3
	<b>Compressor current</b>	A	29	46
	<b>Absorbed power (standard centrifugal fans)</b>	kW	35	59
	<b>Absorbed current (standard centrifugal fans)</b>	A	68	103
	<b>Absorbed power (high pressure centrifugal fans)</b>	kW	37	61
	<b>Absorbed current (high pressure centrifugal fans)</b>	A	88	131
	<b>Absorbed power (radial fans)</b>	kW	35	59
	<b>Absorbed current (radial fans)</b>	A	67	101
	<b>Maximum absorbed power</b>	kW	62	86
	<b>Maximum absorbed current</b>	A	97	146
	<b>Inrush current</b>	A	269	406
	<b>Power supply</b>	V/Ph/Hz	400 / 3~ + N / 50	400 / 3~ + N / 50
<b>Hot Water Coil</b>	<b>Heating capacity hot water coil</b>	kW	168	235
	<b>Nominal flow hot water coil</b>	m <sup>3</sup> /h	14,45	20
	<b>Hot water coil pressure drop</b>	kPa	60	80
<b>Aeraulic Data</b>	<b>Supply fans</b>	no.	4	5
	<b>Recirculation airflow</b>	m <sup>3</sup> /h	25000	35000
	<b>Useful static pressure (standard centrifugal fans)</b>	Pa	200	200
	<b>Useful static pressure (high pressure centrifugal fans)</b>	Pa	300	300
	<b>Useful static pressure (radial fans)</b>	Pa	400	280
<b>Desuperheater</b>	<b>Desuperheater heating capacity</b>	kW	37	55
	<b>Desuperheater water flow rate</b>	m <sup>3</sup> /h	6,4	9,5
<b>General Data</b>	<b>Dimensions (base x depth x height)</b>	mm	1000 x 3390 x 1640	1000 x 4430 x 1640
	<b>Weight</b>	kg	1250	1550
	<b>Sound pressure level</b>	db (A)	73	74
<b>External unit (IT-ST only)</b>	<b>Maximum power</b>	kW	5,82	3,88
	<b>Maximum current</b>	A	11,7	7,8
	<b>Power supply</b>	V/Ph/Hz	400 / 3~ + N / 50	400 / 3~ + N / 50
	<b>Dimensions (base x depth x height)</b>	mm	5550 x 1100 x 1144	3800 x 1100 x 1144
	<b>Weight</b>	kg	535	332
	<b>Sound pressure level</b>	db (A)	63	61

Dehumidification capacity, cooling capacity, currents and electrical power are declared with ambient air at 30°C/80% RH, nominal flow rate + 50 Pa available; for IT and ST models with external air at 30°C/50% RH.

1. Heating capacity of the hot water coil is declared with water in at 80°C and out at 70°C, air 30°C and nominal flow rate.
2. Water pressure drops are declared at nominal water flow rate
3. Static pressure available is declared at the nominal air flow rate
4. Sound pressure level is measured in free field at distance of 1 m from the unit



**5.2 PERFORMANCE CURVE**

**5.2.1 Frame 2**

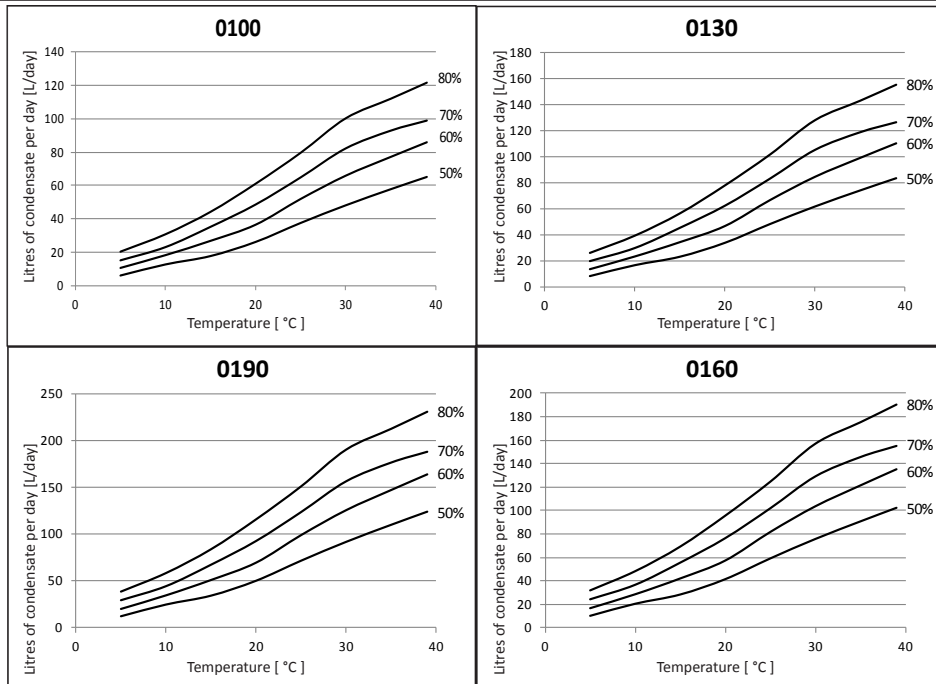

**5.2.2 Frame 3**

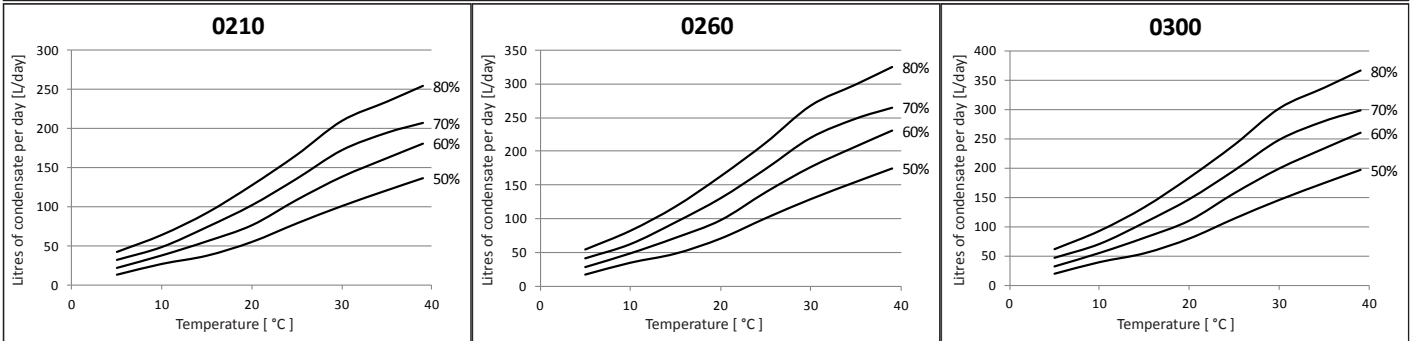

**5.2.3 Frame 4**

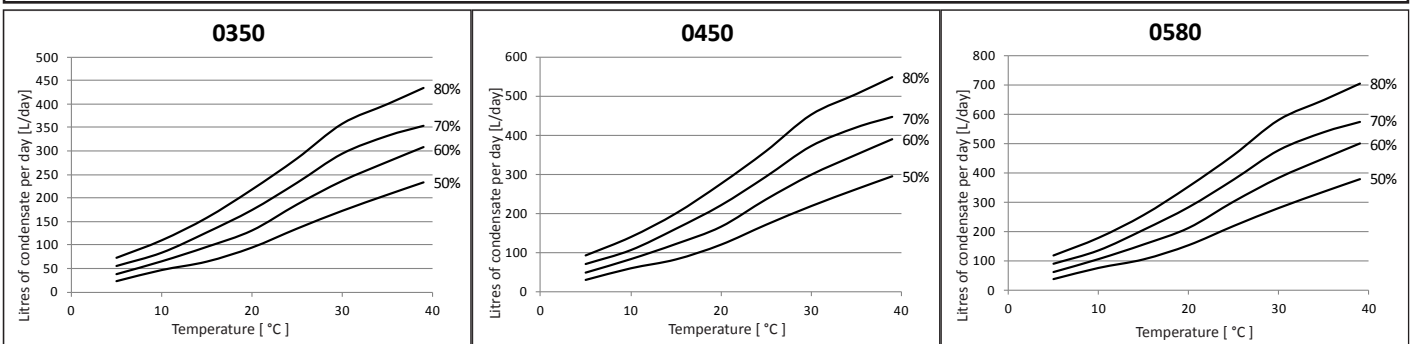

**5.2.4 Frame 5**

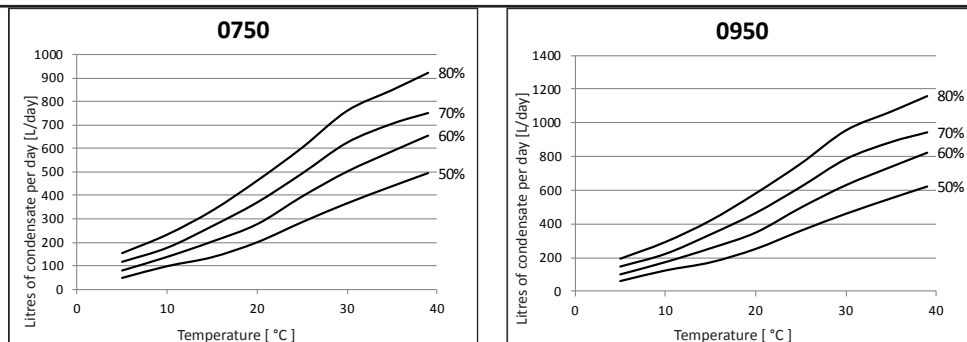

**5.2.5 Frame 6**

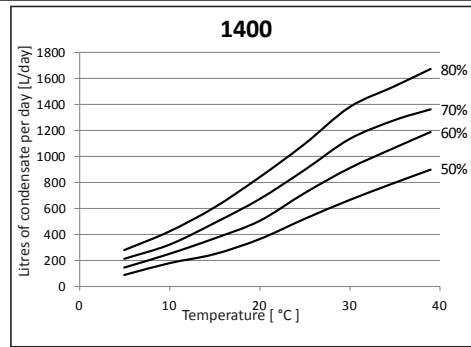
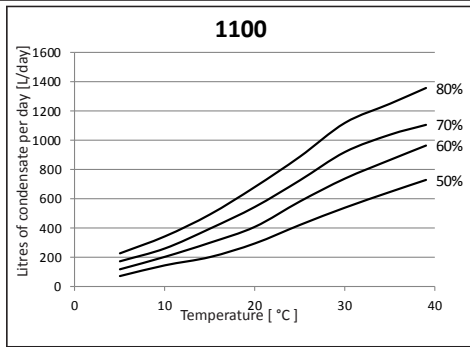

**5.2.6 Frame 7**

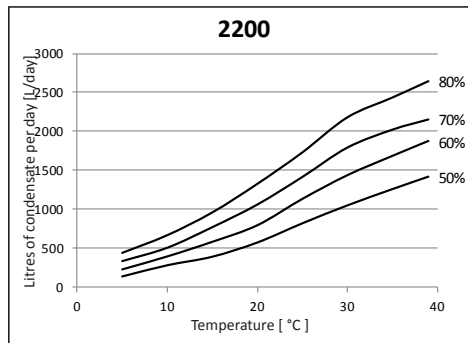
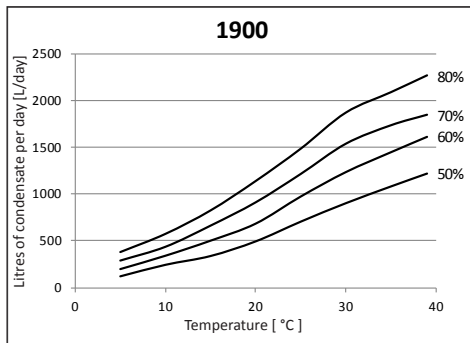
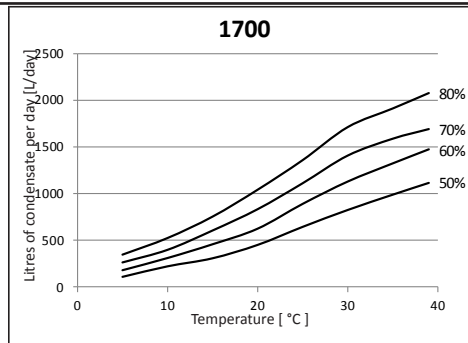
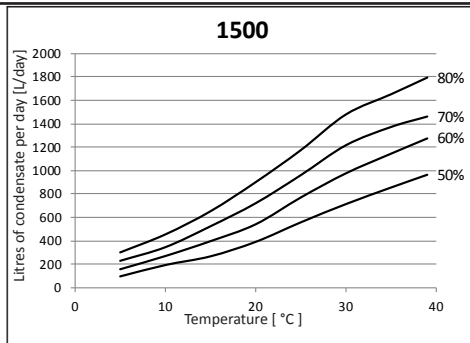

**5.2.7 Frame 8**

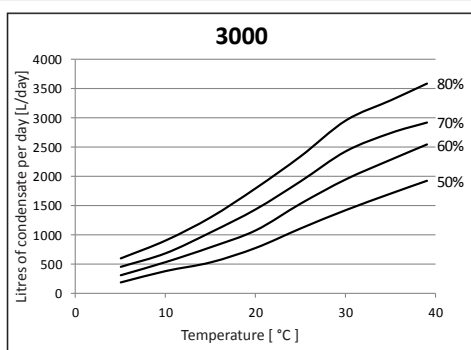

**5.2.8 Frame 9**

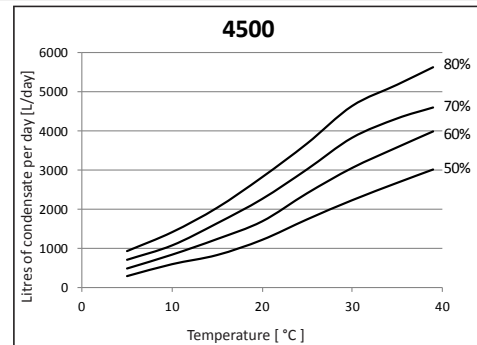

**5.3 OPERATIONAL DIAGRAM**

**5.3.1 ID - SP single circuit**

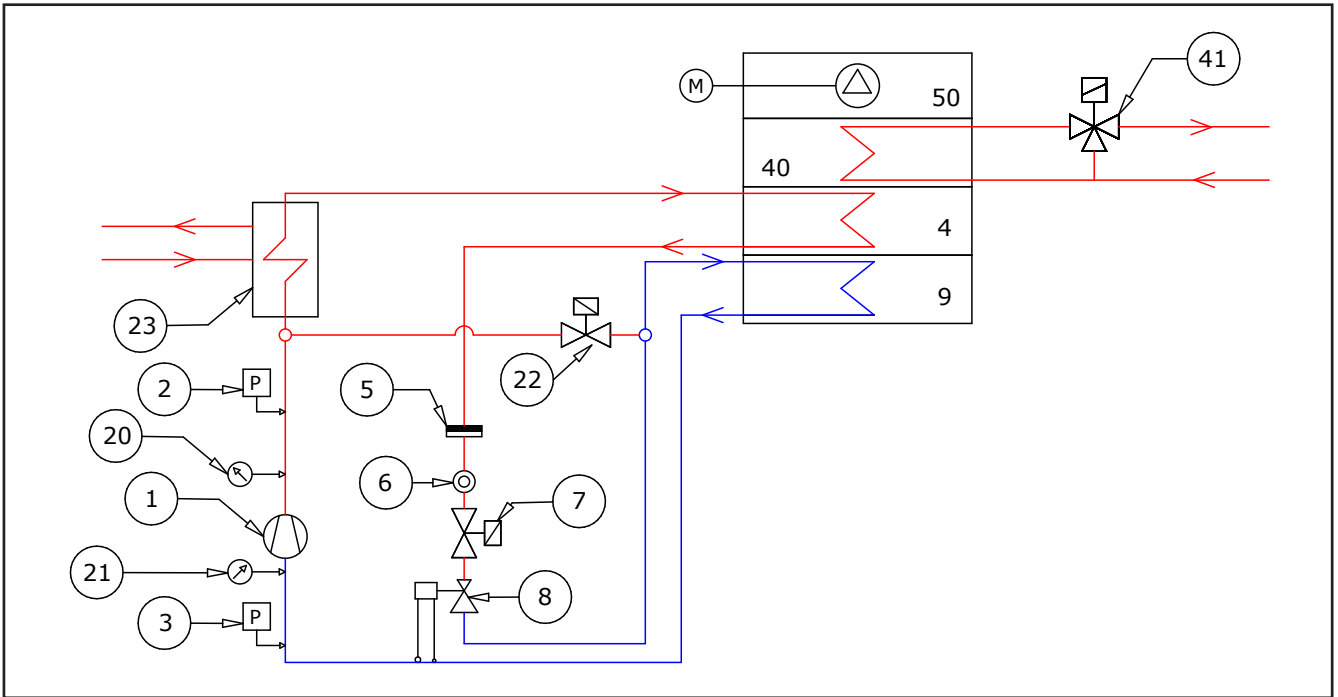

**5.3.2 ID - SP double circuit**

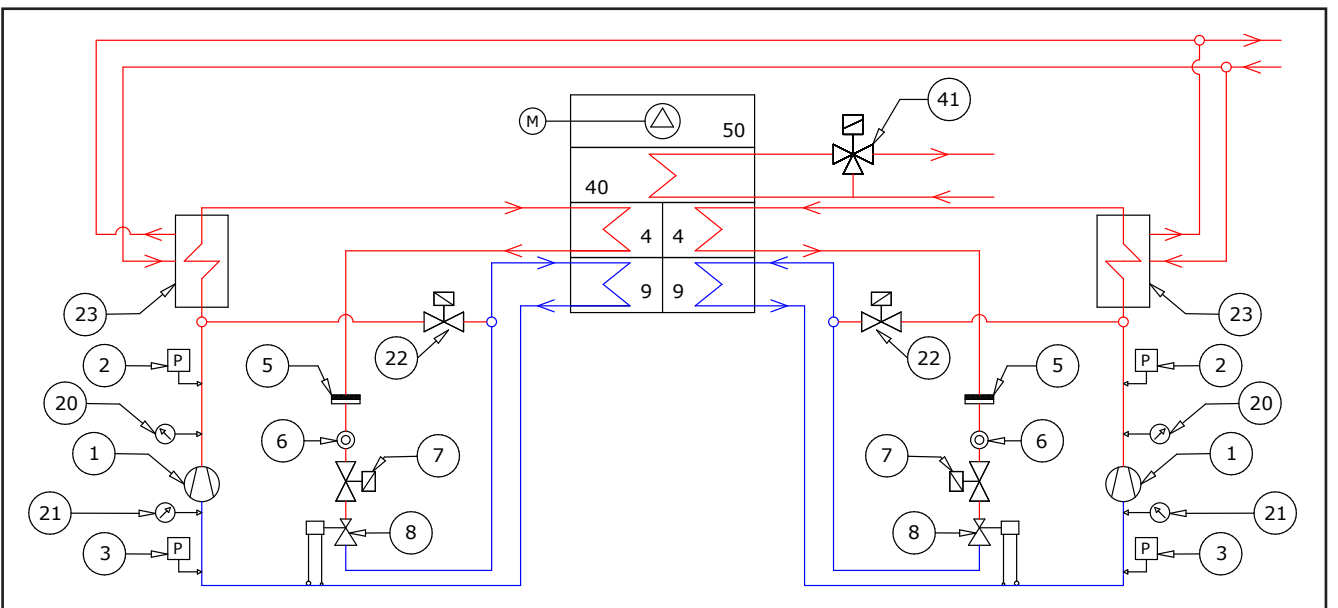

- |    |                                           |    |                                                |
|----|-------------------------------------------|----|------------------------------------------------|
| 1  | compressor                                | 41 | 3-way water valve [optional]                   |
| 2  | high-pressure switch                      | 50 | fan/fans                                       |
| 3  | low-pressure switch                       | 90 | external condensate coil including fan         |
| 4  | condensing coil                           | 91 | high-pressure transducer on external condenser |
| 5  | dehydrating filter                        | 92 | liquid receiver                                |
| 6  | flow indicator                            | 93 | solenoid valve for internal condenser          |
| 7  | liquid solenoid valve                     | 94 | solenoid valve for external condenser          |
| 8  | thermostatic valve,                       | 95 | non-return valve on internal condenser         |
| 9  | evaporating coil                          | 96 | non-return valve on external condenser         |
| 20 | high-pressure gauge [optional]            | 97 | gate valve                                     |
| 21 | low-pressure gauge [optional]             | 98 | low pressure transducer                        |
| 22 | hot gas defrost solenoid valve [optional] |    |                                                |
| 23 | desuperheater [optional]                  |    |                                                |
| 40 | water post-heating coil [optional]        |    |                                                |

5.3.3 IT - ST single circuit

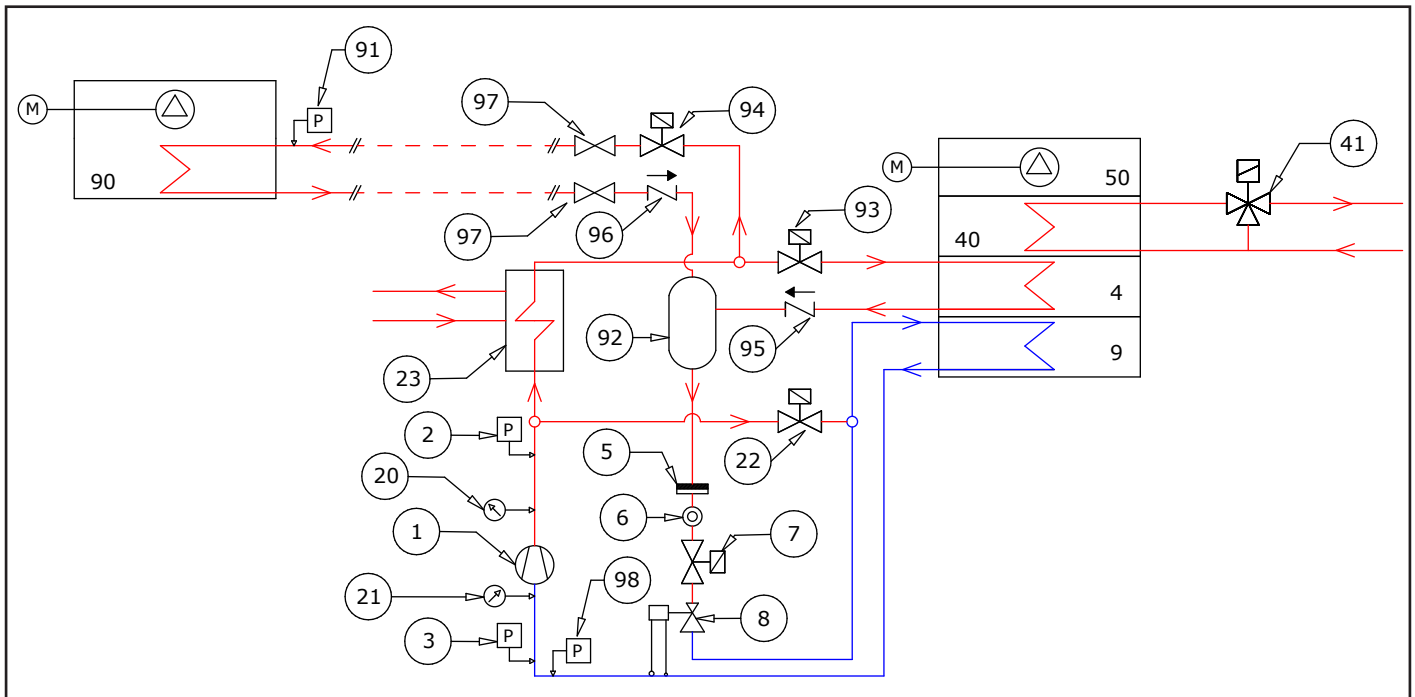

- 1 compressor
- 2 high-pressure switch
- 3 low-pressure switch
- 4 condensing coil
- 5 dehydrating filter
- 6 flow indicator
- 7 liquid solenoid valve
- 8 thermostatic valve,
- 9 evaporating coil
- 20 high-pressure gauge [optional]
- 21 low-pressure gauge [optional]
- 22 hot gas defrost solenoid valve [optional]
- 23 desuperheater [optional]
- 40 water post-heating coil [optional]
- 41 3-way water valve [optional]
- 50 fan/fans
- 90 external condensate coil including fan
- 91 high-pressure transducer on external condenser
- 92 liquid receiver
- 93 solenoid valve for internal condenser
- 94 solenoid valve for external condenser
- 95 non-return valve on internal condenser
- 96 non-return valve on external condenser
- 97 gate valve
- 98 low pressure transducer

5.3.4 IT - ST double circuit

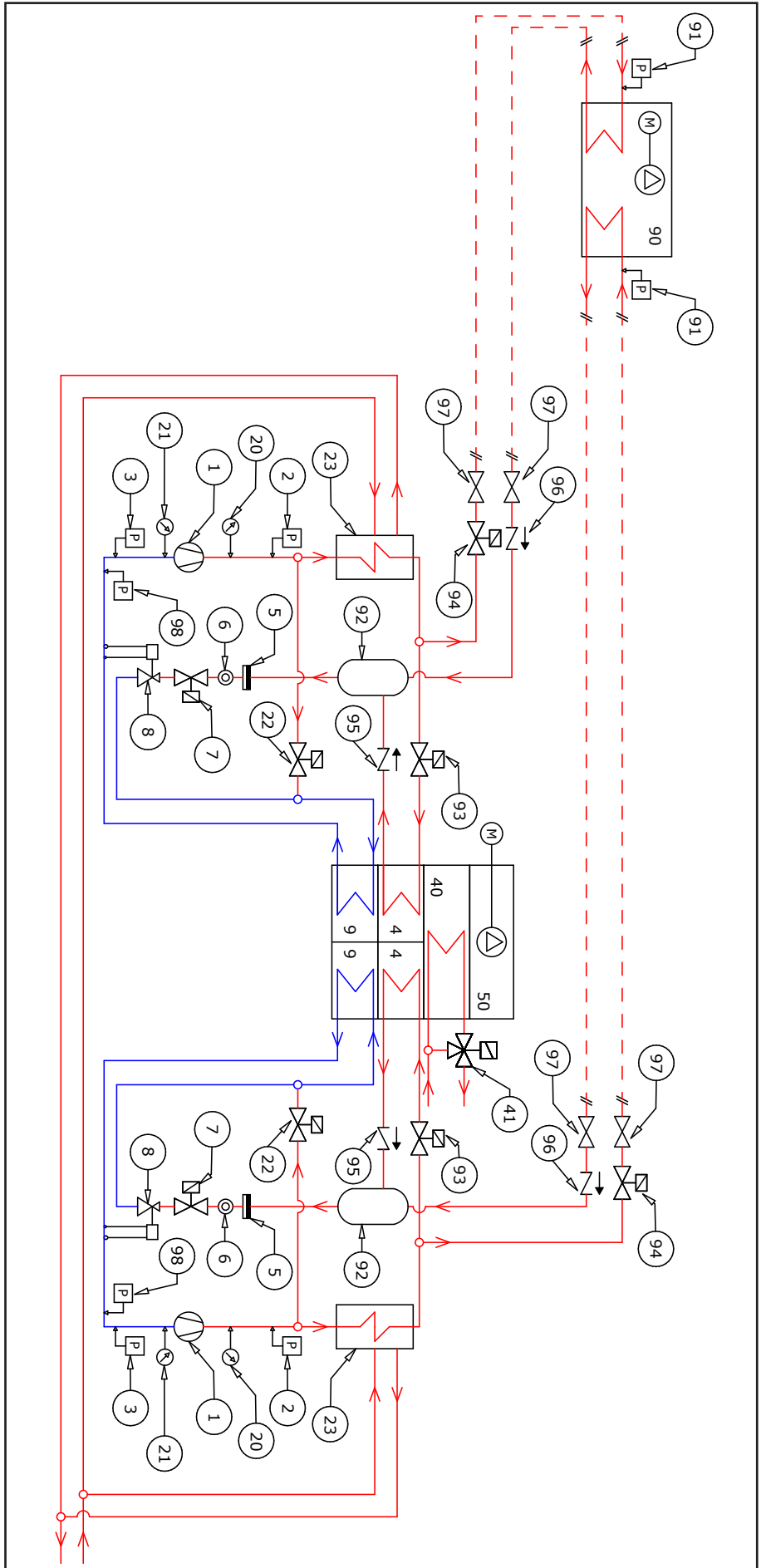

- |    |                                           |    |                                                |
|----|-------------------------------------------|----|------------------------------------------------|
| 1  | compressor                                | 41 | 3-way water valve [optional]                   |
| 2  | high-pressure switch                      | 50 | fan/fans                                       |
| 3  | low-pressure switch                       | 90 | external condensate coil including fan         |
| 4  | condensing coil                           | 91 | high-pressure transducer on external condenser |
| 5  | dehydrating filter                        | 92 | liquid receiver                                |
| 6  | flow indicator                            | 93 | solenoid valve for internal condenser          |
| 7  | liquid solenoid valve                     | 94 | solenoid valve for external condenser          |
| 8  | thermostatic valve,                       | 95 | non-return valve on internal condenser         |
| 9  | evaporating coil                          | 96 | non-return valve on external condenser         |
| 20 | high-pressure gauge [optional]            | 97 | gate valve                                     |
| 21 | low-pressure gauge [optional]             | 98 | low pressure transducer                        |
| 22 | hot gas defrost solenoid valve [optional] |    |                                                |
| 23 | desuperheater [optional]                  |    |                                                |
| 40 | water post-heating coil [optional]        |    |                                                |

**6 MAINTENANCE AND TROUBLESHOOTING**

**6.1 TROUBLESHOOTING**

**6.1.1 Signalling faults**

Alarms on the units with basic control are signalled by a red light, next to the control unit.  
Alarms on the units with advanced control are signalled by the alarm bell button, next to the display.

**6.1.2 Troubleshooting**

On the next pages there is a list of the most common reasons that may cause the unit to block or, at least, malfunction. They are listed according to the easily identifiable symptoms.



*Pay attention performing the operations suggested for solving the problems: lack of concentration can cause injuries, even serious ones. We recommend contacting the manufacturer or a qualified technician after having identified the cause.*

FAULT	ANALYSIS OF POSSIBLE CAUSES	CORRECTIVE ACTIONS
The unit does not start	No electrical power supply to the unit	Check its presence on the power supply terminals
	No power supply to the electronic board	Check its presence on the terminal boards
	There are alarms present	Check the presence of alarms on the terminal, eliminate the causes and restart the unit.
	Phase sequence relay cut-out (only on model 210)	Check if the sequence of phases is correct (refer to paragraph 8.5.1.)
The compressor does not start	Internal thermal protector cut-out	Unplug the unit, wait for the compressor to cool down and check to see if it restarts by reconnecting the power supply. Identify the cause of the intervention and eliminate it
	High-pressure protection on the refrigerating circuit	Refer to the "High pressure" fault
	Low-pressure protection on the refrigerating circuit	Refer to the "Low pressure" fault
	The set temperature and humidity values do not allow start-up	Define different set of values
	The ambient temperature is too high or too low.	Change the room temperature to between 8°C and 41°C. The minimum limit can be lowered to 2°C with the hot gas defrost option
The fan is noisy.	An excessively high flow rate has been set.	Check the flow rate and lower it, if necessary.
	Air ducts have been installed that are too small and/or with too many bends	Check the air duct layout and correct it
High pressure	Air flow is inadequate	Check if the filters and heat exchange coils are clean. Check that all the fans are turning correctly.
	High pressure switch cut-out.	Reset the pressure switch manually by pressing the red button above it (do not reset the pressure switch more than three times. Call a specialised technician)
	Other causes	Call a specialised technician
Low pressure	Air flow is inadequate	Check if the filters and heat exchange coils are clean. Check that all the fans are turning correctly.
	A leak in the refrigerating circuit has lost all of part of the gas.	Call a specialised technician
	Other causes	Call a specialised technician

FAULT	ANALYSIS OF POSSIBLE CAUSES	CORRECTIVE ACTIONS
Ventilation alarm	There is a problem on a fan	Call a specialised technician
Overheating of electric elements	Air flow is inadequate	Check if the filters and heat exchange coils are clean.
		Check that all the fans are turning correctly.
	Other causes	Call a specialised technician
E0	Incorrect reading of ambient air sensor	Check the connection to the sensor and that the sensor is working.
E1	Incorrect reading of evaporation sensor	Check the connection to the sensor and that the sensor is working.
E2	Other causes	Call a specialised technician
EL	Air temperature too low	Increase the air temperature
EH	Air temperature too high	Decrease the air temperature

## 6.2 ORDINARY MAINTENANCE

### 6.2.1 Cleaning and replacing air filters

Standard unit



Unit with filter holder

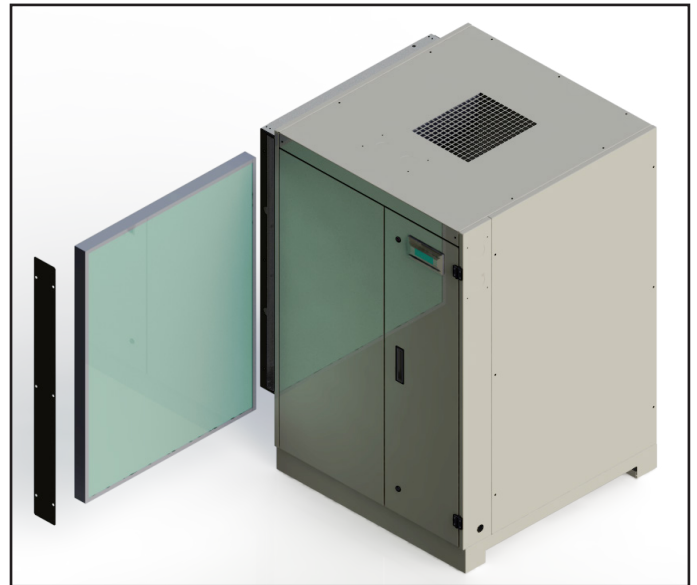

Open the panel containing the filter, slide the filter out and clean it sucking, manually remove any impurities that may prevent proper airflow, taking care not to damage it.



- It is extremely important to always insert suction filters on the unit. Without them, the unit will not work properly.
- Any ruined, punctured or otherwise damaged filter must always be replaced.
- Do not use water to clean filters

## 6.3 MAINTENANCE TABLE

Execution of maintenance operations indicated in the table allows to:

- Grant constant performance in the time
- Keep unit in good conditions in order to prevent deterioration

Operation	Frequency
Air filters	<ul style="list-style-type: none"> <li>• Visual check and cleaning every 3 months (or more frequently in case of dirty ambiances)</li> <li>• Replacement at least every 6 months</li> </ul>
Check correct condensate discharge downstream the unit	Every 6 months
Check pulizia bocchette e griglie aria, interne ed esterne	Every 6 months
Visual and acoustic check (check noise emitted and unit integrity)	Every 6 months
Visual check of refrigerating circuit (oil leakage, refrigerant, ...)	See F-GAS table, if not indicated every 12 months
Visual check of hydraulic circuit (water leakage, ...)	Every 12 months
Visual check of electrical panel, wiring and cables	Every 12 months
Fans status and fixing	Every 4 years
Condensate tray cleaning	Every 2 years
Thermal exchange coils cleaning	Every 2 years
Corrosion presence	Every 12 months
Supply voltage, supply cable check and insulation	Every 12 months
Power contactors status and crankcase heater (compressor)	Every 12 months

## 6.4 MAINTENANCE REGISTER

Register in the table below ordinary and extraordinary operations executed.

Operation	Year _____		Year _____		Year _____		Year _____	
	1° sem	2° sem	1° sem	2° sem	1° sem	2° sem	1° sem	2° sem
Air filters								
Check correct condensate discharge downstream the unit								
Check air vents and grilles cleaning, indoor and outdoor								
Visual and acoustic check (check noise emitted and unit integrity)								
Visual check of refrigerating circuit (oil leakage, refrigerant)								
Visual check of hydraulic circuit (water leakage, ...)								
Visual check of electrical panel, wiring and cables								
Fans status and fixing								
Condensate tray cleaning								
Thermal exchange coils cleaning								
Corrosion presence								
Supply voltage, supply cable check and insulation								
Power contactors status and crankcase heater (compressor)								

Extraordinary maintenance

---



---



---



---



## 7 DECOMMISSIONING THE SYSTEM

When the unit reaches the end of life and must be removed and replaced, it is necessary to follow some indications:

- the refrigerant contained should be recovered by specialised personnel and sent to a waste collection facility;
- the lubricating oil in the compressors should be recovered and sent to a waste collection facility;
- If the structure and the various components cannot be use, they should be demolished and divided into material types. This is particularly important for copper and aluminium of which there are significant quantities in the machine.

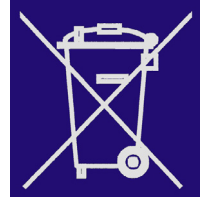

This will facilitate the work carried out in the waste collection, disposal and recycling facilities and minimise the environmental impact of such processes.



*Should the unit, or a part of it, be decommissioned, the parts liable to cause any hazard must be rendered harmless.*

When a component is replaced, the used one must be disposed of separately referring to the applicable law.

It is mandatory to register the loading and unloading of special and toxic-harmful waste.

Special and toxic-harmful waste must be collected by authorised companies.

Special and toxic-harmful waste must be disposed of in compliance with the applicable laws in the user's Country.

Dismantle the unit according to the requirements imposed by the applicable laws in the user's Country.

Before demolishing the unit, ask the relative Authority to perform an inspection and issue a report.

Scrap the unit in compliance with the applicable laws in the user's Country.



*Qualified personnel must dismantle and demolish the unit.*

### 7.1 ENVIRONMENTAL PROTECTION

The law [reg. EC 2037/00] that regulates the use of stratospheric ozone-depleting substances and greenhouse gases, bans the disposal of refrigerant gases in the environment and requires holders to collect them and return them to the dealer at the end of their useful life or take them to a suitable waste collection facility.

The refrigerant R410A is not harmful to the ozone layer, but is included among the substances responsible for the greenhouse effect and thus falls within the scope of the aforesaid regulations.



*Pay particular attention carrying out maintenance work to minimise refrigerant leaks.*

### 7.2 WASTE ELECTRICAL AND ELECTRONIC EQUIPMENT MANAGEMENT (WEEE)

This product falls within the application scope of the Directive 2012/19/EU concerning the management of waste electrical and electronic equipment (WEEE). Equipment must not be disposed of with household waste as it is made of different materials that can be recycled at special facilities. Please inquire through your municipal authorities as to the location of the eco-friendly waste management sites where waste can be received for disposal and its subsequent recycling as recommended. Furthermore, please note that, when an equivalent appliance is purchased, the seller is expected to collect free of charge the old product to be disposed of. The product is not potentially dangerous for human health and the environment, as it does not contain any harmful substances according to the Directive 2011/65/EU (RoHS), but if disposed of freely in the environment, it might adversely affect the ecosystem. Read the instructions carefully before using the equipment for the first time. It is strongly recommended not to use the product for any purpose other than that for which it was designed, to prevent the risk electric shock if the product is used incorrectly.

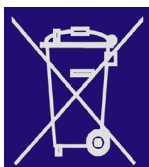

The crossed-out wheeled bin symbol on the equipment label indicates that the equipment is compliant with the Waste Electrical and Electronic Equipment (WEEE) Directive.

Disposing of the equipment freely in the environment or illegally disposing of the equipment are punishable by law.

## 8 INSTALLATION

### 8.1 INTRODUCTION

#### 8.1.1 Inspection

On receiving the unit, check for any damage: the machine left the factory in perfect conditions; immediately report any signs of damage to the carrier and note them on the "Delivery Slip" before signing it.

The manufacturer or its agent must be promptly notified of the extent of the damage.

The Customer must submit a written report describing all significant signs of damage.

#### 8.1.2 Lifting and transport

While the unit is being unloaded and positioned, utmost care must be taken to avoid abrupt or rough manoeuvres. Be very careful when transporting it inside. Do not use the unit components for lifting purposes.



*In all lifting operations make sure that the unit is properly secured to prevent accidental falls or overturning. Do not move or lift the unit by the removable panels.*

#### 8.1.3 Unpacking

The unit packaging must be removed with care to avoid damaging the machine. Different packing materials have been used: wood, cardboard, nylon etc. They should be separated and taken to suitable waste disposal or recycling facilities to minimise their environmental impact.

#### 8.1.4 Identification of the unit

Each unit has an identification plate on the inner compartment of the electric panel, which bears all the data required for installation, maintenance and unit traceability.

Take note of the model, serial number, the definitive refrigerant load and the reference drawings of the unit found in the table on the side, so that it can easily be retrieved if the data plate gets worn.

Modello - Model	
Matricola - Serial number	
Data di produzione - Date of production	
Categoria PED/ CE 97/23 Category	
Procedura di valutazione conformità - Conformity module	
Max temp. di stoccaggio - Max storage temperature [°C]	
Max temp. funzionamento - Max ambient working temperature [°C]	
Min. temp. ambiente di funzionamento - Min. ambient working temp. [°C]	
Potenza frigorifera nominale - Nominal Cooling Capacity [kW]	
Potenza nominale in riscaldamento - Nominal Heating Capacity [kW]	
Refrigerante - Refrigerant [ASHRAE 15/1992]	
Carica refrigerante - Refrigerant charge [kg]	
Peso a vuoto - Empty weight [kg]	
Alimentazione - Power supply	
Potenza assorbita Nominale - Nominal power input [kW]	
Corrente nominale - Nominal absorbed current [A]	
Corrente massima - Full load ampere FLA [A]	
Corrente di spunto - Starting Current LRA [A]	
Schema elettrico - Wiring diagram	
Schema frigorifero - Refrigeration diagram	

## 8.2 PLACEMENT

Units are designed for INDOOR installation (except unit with outdoor version), fixed position (except unit with wheels).

Reduce vibration transmission installing antivibration devices on supporting points and/or flexible joints on hydraulic/aerualic connections.

Install the unit considering following indications:

- Customer approval
- Safe accesible position
- Clearances for correct operation
- Unit weight and supporting points capacit
- Unit in bubble level
- Ambiences without acid, corrosive, aggresive substances or other pollutants and/or dusts
- Hydraulic connections
- Electrical connections



**ATTENZIONE  
WARNING**

*Ensure there is sufficient space to remove the filters from the machine which may be as long as the entire suction duct. You should have complete access to it.*

*Ensure there is sufficient space in front of the electrical panel to allow any technical work to be performed on it.*



**ATTENZIONE  
WARNING**

*Do not install the unit outside and make sure it is not exposed to atmospheric agents such as rain, hail, moisture, and frost; except unit with outdoor version.*

### 8.3.1 Installation place conditions



**ATTENZIONE  
WARNING**

*Temperature and humidity conditions of installation place have to respect limits indicated in «Opearting Limits» paragraph. Inobservance of these limits could damage the unit.*

### 8.2.1 External condenser (IT - ST only)

All the external condensers have been designed for both internal and external installation.

## 8.3 HYDRAULIC AND ELECTRICAL CONNECTIONS

### 8.3.1 Hydraulic connection

It is mandatory to follow the requirements below, when implementing the hydraulic circuit, to comply with the following requirements and in any case, comply with national or local regulations.



**ATTENZIONE  
WARNING**

*Do not distort the hydraulic connections for the unit under any circumstances. Block the unit connections with a spanner and then, turn the hydraulic coupling connections with another.*

Use flexible joints to join the pipes in order to dampen vibrations and to compensate for thermal expansion.

The following components should be installed on the piping:

- zone valve (if not required as an option and, therefore, already present in the dehumidifier);
- temperature and pressure indicators for routine maintenance and inspections of the unit. Pressure control allows you to assess the correct functioning of the expansion tank and to detect water leakage in advance;
- shut-off valves (gate valves) to isolate the unit from the water circuit for maintenance;
- metal mesh filter (inlet piping) with mesh no larger than 1 mm, to protect the heat exchanger from waste or impurities inside the piping. This requirement is, above all, necessary for commissioning;
- air vent valve placed on the higher parts of the hydraulic circuit to bleed the air. The pipes inside the machine are fitted with manual air vent valves to bleed the unit: this operation should be carried out when the unit is switched off.
- discharge cock and drain tank, where needed, in order to empty the system for maintenance;
- for process applications, it is recommended to install a decoupling heat exchanger, which avoids the fouling of the heat exchangers



**AVVERTENZA  
CAUTION**

*It is extremely important that the water inlet is connected at the height of the “Water Inlet” sign. Otherwise the countercurrent circuitry would not be respected with the risk of malfunction, blockage or breakage of the unit.*

The dimensions and position of the hydraulic connections are indicated in the dimension tables and assembly drawings.



**ATTENZIONE  
WARNING**

*Water circuit must guarantee a constant nominal flow rate of water (+/- 15%) in all operating conditions.*

### 8.3.2 Condensate discharge connection

Connect with a flexible rubber hose with an internal diameter of 16 mm. A siphon is created in the unit on the discharge pipe.



**ATTENZIONE  
WARNING**

*Discharge pipe slope must be such as to drain the water from the unit to the outside in all cases. If this does not happen, and the condensate tray inside the unit is filled, overflows may occur with consequent water leakage.*

### 8.3.3 Electrical connection



**PERICOLO  
DANGER**

*Wiring must be carried out when the power supply is disconnected.  
DANGER OF DEATH*



**PERICOLO  
DANGER**

*Ground connection is mandatory. The installer must connect ground wire with ground terminal on the electrical panel marked in yellow and green.*



**ATTENZIONE  
WARNING**

*Electrical connection and protections must be implemented according to the wiring diagram and in compliance with local and international regulations. Supply cables have to be designed and realized by personnel qualified to electrical plant design in compliance with local and international regulations and referring to wiring diagram.*

Always refer to the electrical wiring diagram as a whole. The following indications are generic and do not fully cover the electrical installation of the unit.

Open electrical panel, insert the power cord and other cables required into the holes provided, connect to the terminals and mains switch, then close the panel.

For IT and ST models, hook up the electric power supply for the external condenser; no connection cables are required between the unit and the external condenser.

### 8.4 CLEARANCES



**ATTENZIONE  
WARNING**

*Unit has to be installed respecting clearances indicated in the table.*

*Pay attention also to the hydraulic and aeraulic piping, in particular keep clear electrical panel side and filter access panel.*

Clearances	E	F	G 2
	[mm]	[mm]	[mm]
0100 - 0130 - 0160 - 0190	600	700	600
0210 - 0260 - 0300	600	1000	600
0350 - 0450 - 0580	600	1000	600
0750 - 0950	600	1500	600
1100 - 1400	600	1000	800
1500 - 1700 - 1900 - 2200	600	1500	800
3000	600	1500	800
4500	600	1500	800

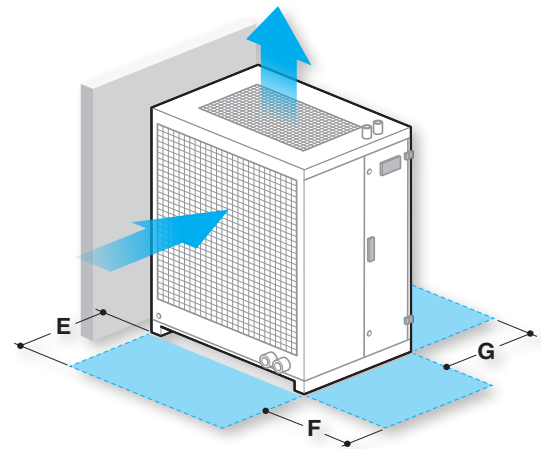

2. In case of in-line supply G clearance has to be referred to the height over the unit.

Remote Condenser	L	M	N	O	P
	[mm]	[mm]	[mm]	[mm]	[mm]
0100 - 0130 - 0160 - 0190	700	600	800	800	free side
0210 - 0260 - 0300	700	600	800	800	free side
0350	700	600	800	800	free side
0450 - 0580	700	1200	800	800	free side
0750 - 0950	700	1200	800	800	free side
1100 - 1400	700	1200	800	800	free side
1500 - 1700 - 1900 - 2200	800	1200	800	800	free side
3000	800	1200	800	800	free side
4500	800	1200	800	800	free side

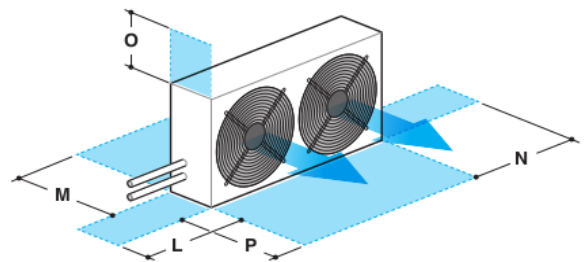

## 8.5 REFRIGERATING CONNECTIONS (IT - ST ONLY)

### 8.5.1 Instructions for connecting the external condenser

The IT and ST units have an external condenser which allows the excess heat to be disposed of externally and air condition the room.



*All refrigerating circuit work (laying pipes, soldering of pipes, bends and joints, installation of refrigerating components, circuit pressure, vacuum, gas load, etc.) should only be carried out by specialised personnel with a valid license.*



*All these operations should be carried out with the power supply switched off.*

The maximum distance between the unit and the external condenser is 30 metres, i.e. the combined length of the inlet pipe and the liquid pipe must not exceed 60 metres which is the maximum length for each circuit. The maximum height allowed is 10 metres.

The external condenser is supplied filled with nitrogen (maximum pressure 10 bar), therefore, the refrigerating technician must:

- 1 make sure that the unit and the external condenser are disconnected from the power supply;
- 2 connect the pressure gauges to the external condenser to check that it is still pressurised and there have been no leaks during transportation, and check the placement and fastening;
- 3 position all the pipes, joints, bends and all the material for the refrigerating connection;
- 4 empty the nitrogen from the external condenser circuits;
- 5 remove all the welded caps from the external condenser;
- 6 solder all the components taking care not to overheat the delicate parts, such as the unit valves and the pressure transducers in the external condenser. Always place a wet rag on the delicate parts to lower the heat;
- 7 carry out a visual check of the entire circuit and make sure there are no leaks or cracks;
- 8 charge the new pipes and the external condenser with nitrogen to a pressure of about 16 bar;
- 9 wait at least 24 hours and check the pressure of all the circuits. If the pressure has dropped, there is a leak. Look for the leak, then empty the nitrogen and repair the leak. Repeat the operations from point 8;
- 10 if there are no leaks in the refrigerating circuit, create a vacuum in each circuit of the external condenser and consequently of the new pipes;
- 11 add R410A gas as per the indications on the next page;
- 12 open the valves on the unit.

### 8.5.2 Sizing of the refrigerating pipes, refrigerant charging and oil top-up.

The following table shows the sizes of the pipe connections of the internal and external units.

Model	um	130	160	190	210	260	300	350	450	580	750	950	1100	1400	1500	1700	1900	2200	3000
No. refrigerant circuits	no.	1	1	1	1	1	1	1	1	1	1	1	2	2	2	2	2	2	2
IN internal unit	mm	10	10	10	10	10	10	12	12	16	22	22	16	16	16	16	16	22	22
OUT internal unit	mm	10	10	10	12	12	12	12	16	16	22	22	22	22	22	22	22	22	22
IN external unit	mm	16	16	16	18	18	18	18	22	22	28	28	35	35	35	35	35	35	42
OUT external unit	mm	12	12	12	16	16	16	16	16	16	18	18	22	22	22	22	22	22	28

The table on the following page gives all the information required for choosing the pipes, type and quantity of oil and quantity of refrigerant for the external unit connection. All the data indicated in the table is given for each individual refrigerating circuit.

Notes for the table on the following page:

If the total refrigerant charge (unit charge + external condenser charge + refrigerant top-up due to the length of the line) exceeds the maximum charge allowance for the compressor (\*\*), a top-up of 50 g of oil for every kg of excess refrigerant will be required.

The gas charge for the unit is indicated on the silver-plated label.

(\*\*\*) A siphon must be installed every 5 m of vertical inlet line.

Model	130	160	190	210	260	300	350	450	580	750	950	1100	1400	1500	1700	1900	2200	3000
Refrigerant load external condenser	kg	0,6	0,6	0,6	0,6	0,6	1,3	1,4	1,9	1,9	3,8	3,7	3,7	4,5	4,5	4,5	4,5	10
Inlet line (gas)	in (mm)	3/8 (9,5)	3/8 (9,5)	3/8 (9,5)	1/2 (12,7)	1/2 (12,7)	1/2 (12,7)	5/8 (15,9)	3/4 (19)	7/8 (22,2)	7/8 (22,2)	7/8 (22,2)	7/8 (22,2)	7/8 (22,2)	7/8 (22,2)	7/8 (22,2)	7/8 (22,2)	7/8 (22,2)
Liquid line	in (mm)	3/8 (9,5)	3/8 (9,5)	3/8 (9,5)	3/8 (9,5)	3/8 (9,5)	1/2 (12,7)	1/2 (12,7)	5/8 (15,9)	3/4 (19)	3/4 (19)	5/8 (15,9)	5/8 (15,9)	5/8 (15,9)	3/4 (19)	3/4 (19)	3/4 (19)	3/4 (19)
Refrigerant to-up per line metre	kg	0,08	0,08	0,08	0,08	0,08	0,13	0,14	0,22	0,32	0,32	0,23	0,23	0,23	0,32	0,32	0,32	0,32
Oil top-up for individual siphon ***	g	5	5	5	10	10	10	20	34	54	54	54	54	54	54	54	54	54
Inlet line (gas)	in (mm)	1/2 (12,7)	1/2 (12,7)	1/2 (12,7)	5/8 (15,9)	5/8 (15,9)	5/8 (15,9)	3/4 (19)	3/4 (19)	7/8 (22,2)	7/8 (22,2)	7/8 (22,2)	7/8 (22,2)	7/8 (22,2)	7/8 (22,2)	7/8 (22,2)	7/8 (22,2)	7/8 (22,2)
Liquid line	in (mm)	3/8 (9,5)	3/8 (9,5)	3/8 (9,5)	3/8 (9,5)	3/8 (9,5)	1/2 (12,7)	1/2 (12,7)	5/8 (15,9)	3/4 (19)	3/4 (19)	5/8 (15,9)	5/8 (15,9)	5/8 (15,9)	3/4 (19)	3/4 (19)	3/4 (19)	3/4 (19)
Refrigerant to-up per line metre	kg	0,08	0,08	0,08	0,09	0,09	0,14	0,15	0,22	0,32	0,32	0,23	0,23	0,23	0,32	0,32	0,32	0,32
Oil top-up for individual siphon ***	g	10	10	10	20	20	20	34	34	54	54	54	54	54	54	54	54	54
Inlet line (gas)	in (mm)	1/2 (12,7)	1/2 (12,7)	1/2 (12,7)	5/8 (15,9)	5/8 (15,9)	5/8 (15,9)	3/4 (19)	7/8 (22,2)	7/8 (22,2)	1.1/8 (28,6)	7/8 (22,2)	7/8 (22,2)	7/8 (22,2)	7/8 (22,2)	1.1/8 (28,6)	1.1/8 (28,6)	1.1/8 (28,6)
Liquid line	in (mm)	3/8 (9,5)	3/8 (9,5)	3/8 (9,5)	1/2 (12,7)	1/2 (12,7)	1/2 (12,7)	5/8 (15,9)	5/8 (15,9)	3/4 (19)	7/8 (22,2)	5/8 (15,9)	5/8 (15,9)	5/8 (15,9)	3/4 (19)	7/8 (22,2)	7/8 (22,2)	7/8 (22,2)
Refrigerant to-up per line metre	kg	0,08	0,08	0,08	0,14	0,14	0,14	0,22	0,23	0,32	0,45	0,23	0,23	0,23	0,32	0,45	0,45	0,45
Oil top-up for individual siphon ***	g	10	10	10	20	20	20	34	54	54	115	54	54	54	54	115	115	115
Maximum allowance refrigerant load for compressor	kg	2,9	4,7	11,3	11,3	11,3	11,3	11,3	18	22	22	22	22	22	22	22	22	22
Compressor brand		LG	LG	Sanyo	Sanyo	Sanyo	Sanyo	Sanyo	Sanyo	Danfoss	Danfoss	Danfoss	Danfoss	Danfoss	Danfoss	Danfoss	Danfoss	Danfoss
Recommended oil		FVC68D	FVC68D	PVE FV68S	PVE FV68S	PVE FV68S	PVE FV68S	PVE FV68S	PVE FV68S	POE 160SZ	POE 160SZ	POE 160SZ	POE 160SZ	POE 160SZ	POE 160SZ	POE 160SZ	POE 160SZ	POE 160SZ

### 8.5.3 Example:

Unit: ST 2200

Line length: 28 metres (10 vertical metres)

The following values are determined from the table:

- Inlet line diameter: 1 1/8" (28.6mm)
- Liquid line diameter: 7/8" (22.2mm)
- Refrigerant charge external condenser: 4.5 kg
- Refrigerant top-up per line metre: 0.45 kg/metre
- Oil top-up for each siphon: 115 g
- Maximum allowance refrigerant load for compressor: 22 kg
- Oil top-up for every kg of refrigerant in excess: 50 g/kg

The value of the unit refrigerant charge is determined by the silver-plated label: 7 kg

Refrigerant load:

- Top-up charge due to the line length = [line metres] x [gas top-up per line metre] = 28 x 0.45 = 12.6 kg
- Total refrigerant charge = [unit charge] + [external condenser charge] + [top-up charge due to line] = 7 + 4.5 + 12.6 = 24.1 kg
- Top-up refrigerant = [external condenser charge] + [line charge] = 4,5 + 12,6 = 17,1 kg

Oil top-up:

- 10 vertical metres, i.e. 2 siphons
- Oil top-up for the siphons = [oil top-up for each siphon] x [number of siphons] = 115 x 2 = 230 g
- Refrigerant charge over limit = [total refrigerant charge] - [maximum refrigerant charge for compressor] = 24.1 – 22 = 2.1 kg
- Oil top-up for exceeding refrigerant limit = [refrigerant charge over limit] x [oil top-up for every kg of excess refrigerant] = 2.1 x 50 = 105 g
- Total oil top-up = [oil top-up for siphons] + [oil top-up for exceeding refrigerant limit] = 230 + 105 = 335 g

All the values determined refer to a single circuit.

Precautions for long lines (from 20 to 30 metres):

- Inlet check valve: mandatory
- Check valve on liquids: recommended

### 8.5.4 Characteristics of refrigerating pipes

The selection criteria in terms of diameter, material and thickness are given below which are implemented in compliance with the indications given in the EN12735\_1\_2 and EN14276\_2 standards for copper pipes used in refrigerating systems and heat pumps.

The table below shows the calculation of the minimum pipe thickness, for each diameter, in the bends and straight sections in accordance with the EN14276\_2:2011 standard, the minimum curvature radius possible with pressure PT = 50 bar (PS set at 45 bar, therefore PT = 1.5 x PS). Warning: the pipe is not oxidised.

Please consider the commercial thickness in the last column as the minimum usable thickness.

DN	External diameter	Radius of curvature	PT	PED Category	copper $\sigma_s$	Z	Minimum thickness straight	Minimum thickness bend	Commercial thickness
	mm	mm	bar		N/mm <sup>2</sup>		mm	mm	mm
6	6	12	50	A3 P3	100	0,85	0,179	0,285	1
6	8	16	50	A3 P3	100	0,85	0,239	0,265	1
6	10	20	50	A3 P3	100	0,85	0,298	0,331	1
8	12	24	50	A3 P3	100	0,85	0,358	0,397	1
10	16	26	50	A3 P3	100	0,85	0,477	0,529	1
15	18	18	50	A3 P3	100	0,85	0,537	0,595	1
20	22	33	50	A3 P3	100	0,85	0,657	0,728	1,5
25	28	42	50	A3 P3	100	0,85	0,836	0,926	1,5
32	35	52,5	50	A3 P3	100	0,85	1,045	1,158	1,5
32	42	65	50	A3 P3	100	0,85	1,253	1,389	1,5
50	54	108	50	CAT I	100	1	1,375	1,504	1,5
65	64	89	29	CAT I	100	1	0,95	1,052	2
80	76	152	29	CAT I	100	1	1,128	1,250	2

**8.5.5 Inlet line installation (condenser over evaporator/compressor)**

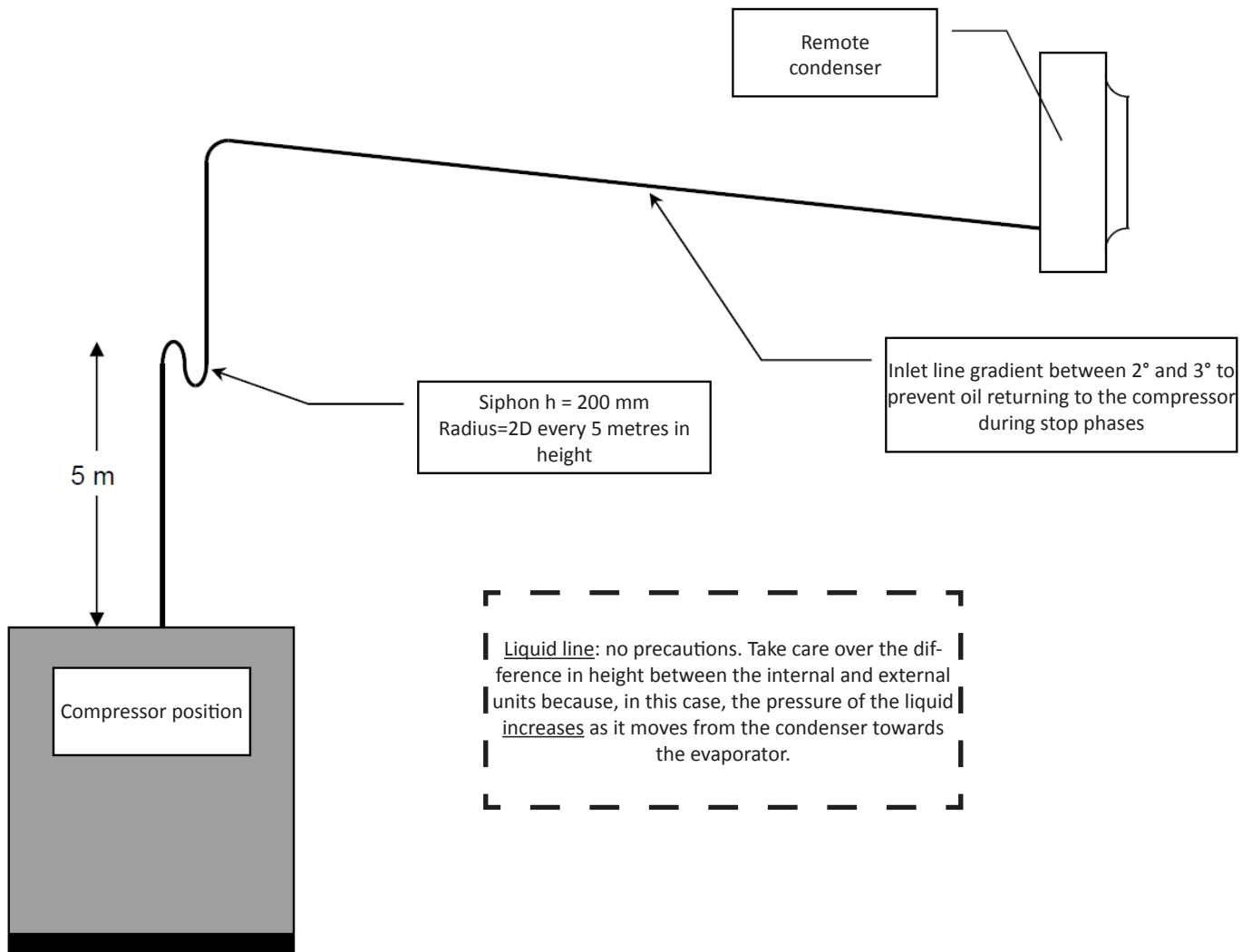



## 8.5.6 Inlet line installation (Condenser below evaporator/compressor)

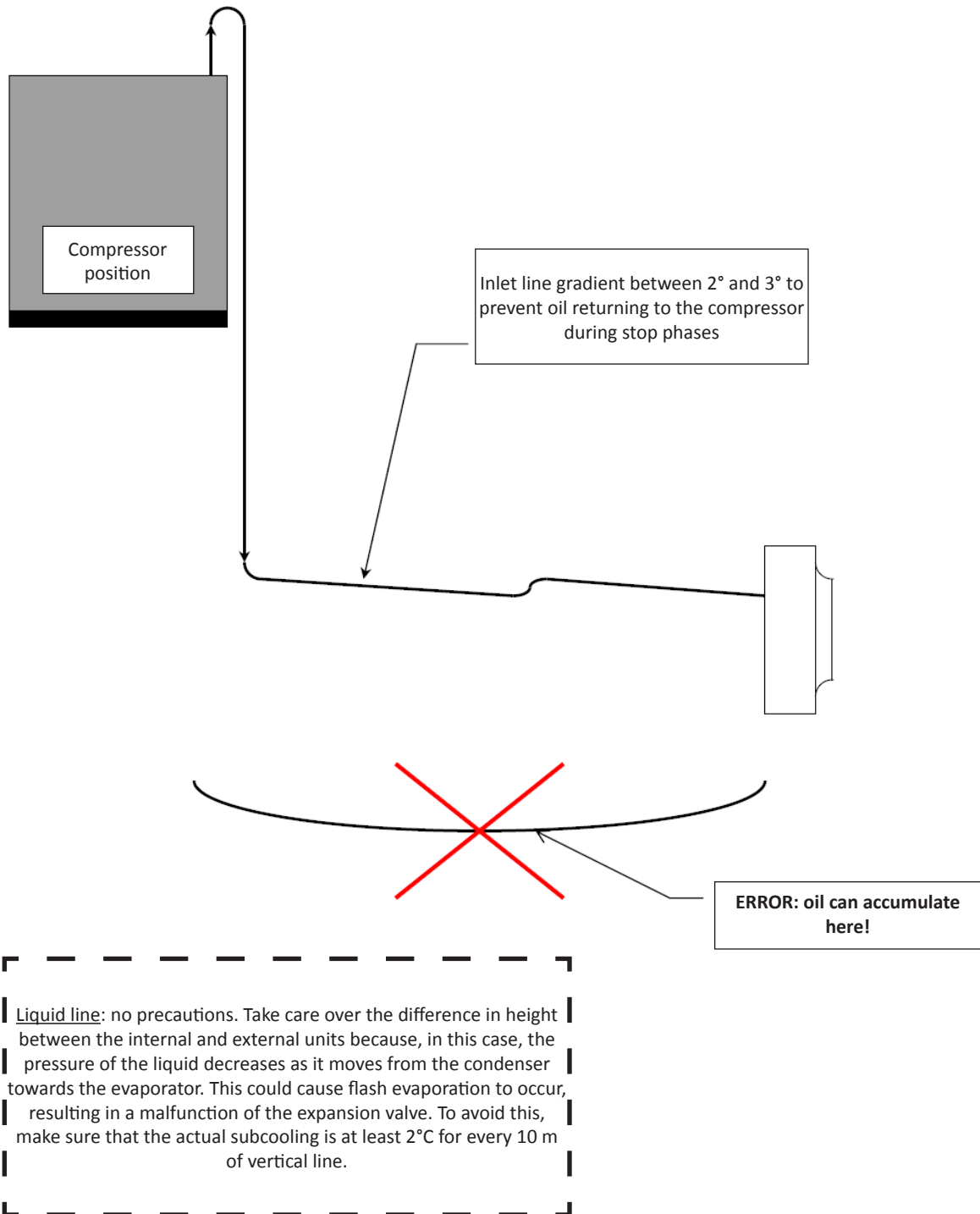

## 8.6 COMMISSIONING

### 8.6.1 Crankcase heater (compressor)

Before switch on the unit, supply compressor crankcase heater for at least 24 hours before compressor starting (completely supplied unit, but switched off).

For example:

- at unit first starting
- after a long stopping period



**Do not start the compressor with crankcase heater active for a period minor than that indicated. In this case warranty becomes void and null.**

### 8.6.2 Startup sequence



**Make sure that all refrigerant, hydraulic, electrical and air duct connections are correctly installed and that all the indications on the labels, user manual and wiring diagram are complied with.**

- compressor crankcase heater active for at least 24 hours
- hydraulic circuit (if present): open taps, vent and verify possible leakage
- close all unit panels
- open circuit voltage measure
- phase sequence check (only from 0210, refers to dedicated paragraph)
- refrigerating circuit (if present, **unit ST-IT**): refers to following paragraphs «Particular indications for IT - ST unit»
- switch on unit
- measure of load voltage (minimum 200 V single-phase, 380 V per three-phase) and absorbed electrical power
- check fan operation
- vibration and/or abnormal noise check
- airflow calibration (except unit with EC radial fan with ACF option)
- complete documentation check

### 8.6.3 Correct phase sequence check (from size 0210)

Check (only models with 3-phase power supply) the correct sequence of the phases.

It is possible to check the correct phase sequence by means of the special relay mounted in the electrical panel. There are two signalling LEDs on the phase sequence relay. When the green LED is on, it indicates all three phases are present. If it is not on, check that to see if the line of one of the three phases has been interrupted. When the yellow LED is on, it indicates that the phases are in the right order. If it is not on, check that the sequence of the phases is correct.



### 8.6.4 SP - ID units startup

Wait initial upload, then switch on unit (refers to user terminal paragraph).

### 8.6.5 Particular indications for ST - IT units

Turn on the external condenser.

In the next steps, you will be asked to change some settings on the display. Always refer to the user terminal sections.

Keep the unit switched off.

Check the gas charge in the circuits. This should be done by a specialised refrigerant technician as indicated previously:

- 1 configure a set of very high temperatures to condense inside the unit (neutral air and not air-conditioned);
- 2 switch on the unit and ensure the compressor or compressors also start (if necessary, low the humidity set);
- 3 Monitor the flow indicator, superheating and subcooling of each circuit. Gas must be charged for every circuit and the thermostat valve adjusted in order:
  - a) to see no bubbles in the flow indicator,
  - b) to have superheating and subcooling within the range of 5 and 8°C;
- 4 to lower the temperature set so that it condenses externally and air conditions internally;
- 5 to check the external condenser is working correctly, when the switch-over to condensing occurs. Hot gas then arrives and the fans must be started;
- 6 Check the flow indicator for each circuit again. If bubbles are present, add gas which may mean the subcooling and superheating are not correct, but this is not a cause for concern;
- 7 the gas charge and circuit optimisation are completed, to adjust the temperature and humidity sets to those requested by the customer.

## 8.7 MODIFYING INSTALLER PARAMETERS

The installer parameters allow you to modify some of the advanced settings of the unit.



**ATTENZIONE  
WARNING**

*Some parameters significantly change the operation of the unit.  
ONLY MODIFY THEM IF NECESSARY AND WITH CARE*

### 8.7.1 Basic user terminal

To access the installer parameter settings menu, you must:

- 1 Hold down the UP (▲) and STAND-BY keys for 5 seconds until the first programmable variable appears on the screen. When you enter the menu, there is an audible beep.
- 2 Use the UP (▲) and DOWN (▼) keys to select the variable to modify.
- 3 You can now modify the value by holding down the SET key and pressing the UP (▲) or DOWN (▼) key.
- 4 When the settings have been changed, hold down the UP (▲) or DOWN (▼) keys (or wait 30 seconds without pressing any keys) until the operating state (OFF or ON) appears on the screen. When you exit the menu, there is an audible beep to confirm.
- 5 The changes made to the variables are automatically saved when you exit the menu.

<i>PARAMETER</i>	<i>DESCRIPTION</i>	<i>VALUES</i>	<i>DEFAULT</i>
<i>F3</i>	Fan status with idle compressor	0 = fan on with unit ON 1 = fan on only with compressor on 2 = fan on with hygrometer contact closed	0
<i>EN3</i>	Non-editable parameter		-
<i>Ad</i>	IP address for RS485 Modbus	from 1 to 247	1
<i>bdr</i>	Modbus baudrate parameter selection	0 = 300, 1 = 600, 2 = 1200, 3 = 2400, 4 = 4800, 5 = 9600, 6 = 14400, 7 = 19200, 8 = 38400.	5

## 8.8 INSTALLER MENU (ADVANCED CONTROL)

To access the installer menu follow the procedure described:

- From the main screen press the key **Prg** to visualize the “Password screen”
- Insert the password “**0010**” and confirm it pressing the key **Enter** ↵

In the installer menu there are three items:

- Change language
- Regulation
- Offset



### USE OF THE KEYS DURING PAGES BROWINGS

- use the **↑ ↓** keys to scroll through the lines
- press **Enter** ↵ to access the highlighted menu
- press the **Esc** key to return to the password request page

### 8.8.1 Change language

It is possible to change the language.

### 8.8.2 Regulation

This menu is composed by 9 pages:

- 1 remote input 1
- 2 remote input 2
- 3 static defrost / hot gas defrost\*\*
- 4 RS485 serial port
- 5 batteria acqua\*
- 6 set-point temperatura\*
- 7 controllo temperatura\*
- 8 fans settings
- 9 set temperatura acqua per resistenze elettriche\*

\* page displayed only with the corresponding option

\*\* page displayed alternatively



### USE OF THE KEYS DURING PAGES BROWINGS

- use the **↑ ↓** keys to scroll through the pages.
- press the **Enter** ↵ key to edit the settings and the first value flashes
- press the **Esc** key to return to the installer page



### USE OF THE KEYS DURING PARAMETERS MODIFICATION

- use the **↑ ↓** keys to change the value that is flashing
- when you press the **Enter** ↵ key, the next value flashes or if it is the last value, you return to the navigation page
- press the **Esc** key to return to the navigation page

### 8.8.3 Remote input 1 / Remote input 2

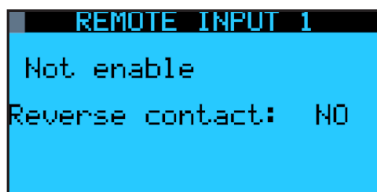

These pages allow to assign the functions to the digital input, chosen from:

1. not enable
2. remote on / off
3. air treatment on / off
4. fresh air forcing (digital input allows to *force* air renewal activation to the 100%)
5. fresh air activation (digital input allows to *enable* air renewal as set on the display)
6. summer / winter

Reverse contact: selecting YES” it is possible to reverse logic of the input

### 8.8.4 Static defrost / Hot gas defrost\*

\* In this page is possible to set the defrost parameters: static defrost (standard) or hot gas defrost (if present option).

```

STATIC DEFROST
Set:                -01.0°C
Diff:               10.0°C
Drain time:         120sec
waiting time:       1200sec
  
```

```

HOT GAS DEFROST
Set:                -12.0°C
Diff:               27.0°C
waiting time:       1200sec
  
```

**Set:** set of the defrost start temperature

**Diff:** temperature difference that has to be reached with defrost

**Drain time:** waiting time, once the temperature is reached

**Waiting time:** minimum time between two successive defrost

*Example: at  $t=-1^{\circ}\text{C}$  defrost starts, it remains active until is reached of  $t= \text{set} + \text{diff} = -1 + 10 = 9^{\circ}\text{C}$ , then unit will wait 120 seconds, at the end it switches on newly with the set function.*

**Set:** set of the defrost start temperature

**Diff:** temperature difference that has to be reached with defrost

**Waiting time:** minimum time between two successive defrost

*Example: at  $t=-12^{\circ}\text{C}$  defrost starts, it remains active until is reached of  $t= \text{set} + \text{diff} = -12 + 27 = 15^{\circ}\text{C}$ , then unit switches on newly with the set function.*

### 8.8.5 RS485 serial port

```

RS485 SERIAL PORT
Abil:               SI
Protocol:           Modbus
Address:            00
Baudrate:           9600
Stop bit:           1
Parita':            nessuna
  
```

In this page is possible to enable the RS485 communication through serial port.

To enable the communication set «YES», other parameters will appear.

Refer to «Serial communication RS485 manual».

### 8.8.6 Water coil (page shown only if present chilled water coil)

```

WATER COIL
Functioning mode:
Cooling and heating
  
```

In this page is possible to set operation mode of the water coil:

- Only cooling
- Cooling and heating

### 8.8.7 Temperature set point (page shown only if present chilled water coil)

```

TEMPERATURE SET-POINT
Set-point mode:
Seasonal set
  
```

There are two possibilities for this page.

1. Choosing "Only cooling" in the previous page, this page is modifiable and it is possible to choose:
  - Seasonal set
  - Unique set
2. Choosing "Cooling and heating" in the previous page, this page is not modifiable and setpoint is "Seasonal set".

### 8.8.8 Temperature control (page shown only if present temperature control option)

```

TEMPERATURE CONTROL
Dead zone:          0.5°C
Differentials
heating:            01.0°C
cooling:            01.0°C
  
```

**Dead zone:** range left and right temperature set within which air treatment does not operate

**Differential heating/cooling:** action step of control

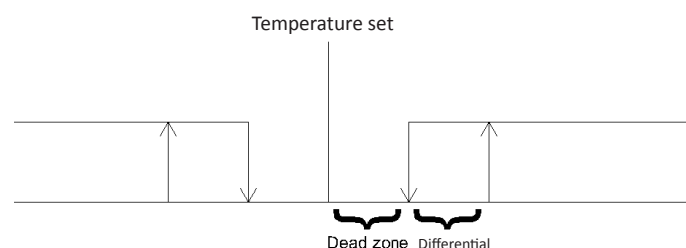

**8.8.9 Fans settings**

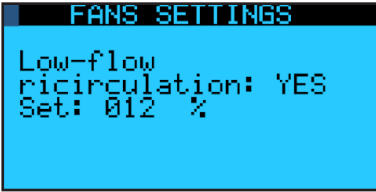

In case of no air treatment the unit reduces fan speed, in this page it is possible to active (YES) / deactivate (NO) this function.

If the function is active (YES) parameter “Set” indicate fan speed and it is modifiable.

**8.8.10 Water temperature set for electrical heater\***

\* This page is shown only if:

- Present hot or chilled water coil mode “Cooling and heating”
- Present electrical heater

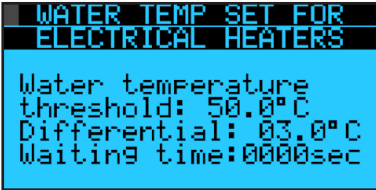

**Water temperature threshold:** minimum inlet coil water temperature, for lower temperature electrical heater will activate

**Differential:** temperature difference that has to be sum to temperature limit so that water coil will activate

**Waiting time:** waiting time before electrical heater activation

**8.8.11 Offset**

This page allows to set the offsets of humidity and temperature probes; an offset is a difference (to sum or to subtract) to the probe read value. If present ACF (Automatic Control Flow) option it is possible to set an offset for fan airflow measured.

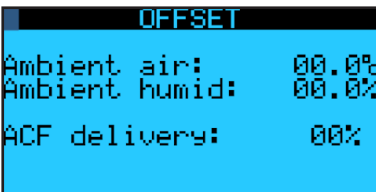

**Ambient air:** indoor air temperature

**Ambient humid:** indoor air relative humidity

**ACF delivery:** ACF supply fan (shown only if present relative option)

## 8.9 CALIBRATION AND CANALIZATION

### 8.9.1 Airflow calibration for units with centrifugal fan

These units do not allow for flow rate adjustment because the fan is not a modulating version.

### 8.9.2 Airflow calibration for units with radial fan and ACF option

If the unit includes the optional ACF (automatic control flow) accessory, calibration of the dehumidifier is not necessary. The unit will adjust automatically the airflow.

### 8.9.3 Airflow calibration for units with radial fan, without ACF option



*If the ACF option is not installed, the flow rates for air intake of the unit should be measured to calibrate the ventilation correctly.*

If the measured airflow is 10% higher or lower than the nominal indicated in the technical datasheet, it is necessary to adjust the fan speed. This function is fundamental to ensure correct operation of the unit.



*Calibration should be carried out by specialised personnel with specific equipment (anemometer) and knowledge of the unit.*



1. From the main screen press the key **Prg**, it appears the password screen.

2. Insert the password "0099" and press **Enter** ↵;

- If the unit was switched on, it appears the screen 2A. It is necessary to exit from the menu pressing **Esc**, switch off the unit (press **Enter** ↵) and repeat the process from point 1.
- If the unit was switched off it appears the screen 2B.

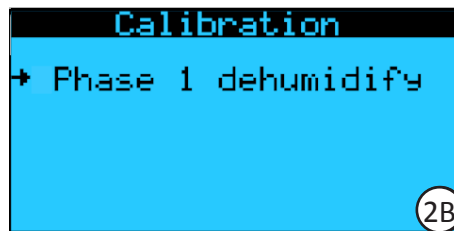
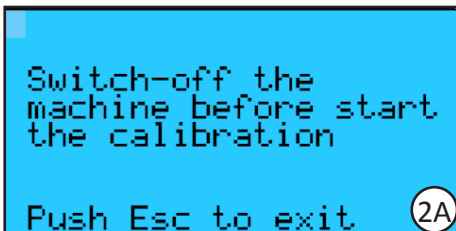

3.1 With screen 2B, press key **Enter** ↵, it will appear the screen 3A, wait 150 seconds. Then it appears the screen 3B.

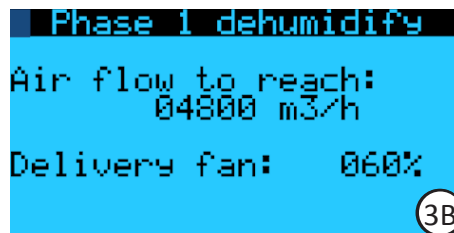
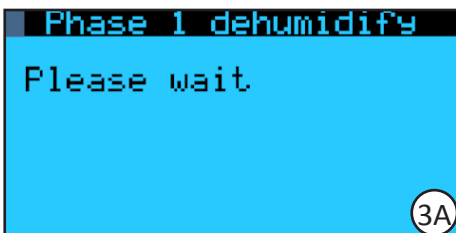

3.2 Press key **Enter** ↵, it is possible to modify with keys **↑** **↓** the supply fan speed and so the air flow. Before modifying the parameter, measure with an anemometer the inlet airflow (see the picture on the side, **point A**) and verify that it corresponds to the airflow shown on the screen. If the airflow doesn't correspond vary the parameter up to reaching the airflow shown.

At the end of the modification press key **Enter** ↵: the cursor will place itself on the upper left corner. Press key **Esc** to come back to installer menu; Press key **Esc** to come back to main screen. Calibration is finished.

### 8.9.4 Unit ducting

Air inlet is not ready for ducting. It is necessary to order complete unit including filter holder frame for inlet ducting. Alternatively, a flanged connector larger than the holes can be used. **WARNING:** it is mandatory to always insert a filter on the air inlet. For air supply ducting, use a flanged connector larger than the holes.

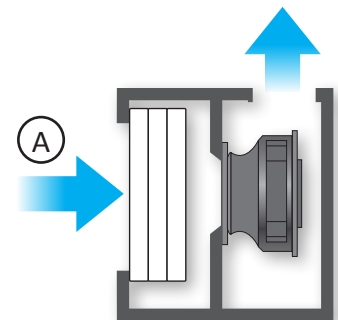

**9 CONTROLS FREQUENCY ACCORDING TO REG. FGAS 517/2014 UE AND ITALIAN DPR 146/2018**

**9.1 MODEL ID-SP**

Size	Refrigerant charge	GWP	Type of circuit	Leakage check frequency
	kg	t equiv CO <sub>2</sub>		
0100	0,75	1,56600	Hermetically sealed	none mandatory check
0130	0,93	1,94184		none mandatory check
0160	1,40	2,92320		none mandatory check
0190	1,40	2,92320		none mandatory check
0210	1,80	3,75840		none mandatory check
0260	2,30	4,80240		none mandatory check
0300	2,48	5,17824		none mandatory check
0350	3,75	7,83000		none mandatory check
0450	4,50	9,39600		none mandatory check
0580	4,45	9,29160		none mandatory check
0750	9,80	20,46240		NOT hermetically sealed
0950	10,30	21,50640	every 12 months	
1100	12,60	26,30880	every 12 months	
1400	12,60	26,30880	every 12 months	
1500	16,50	34,45200	every 12 months	
1700	17,00	35,49600	every 12 months	
1900	18,50	38,62800	every 12 months	
2200	17,60	36,74880	every 12 months	
3000	27,60	57,62880	every 6 months	
4500	38,00	79,34400	every 6 months	

**9.2 MODEL IT-ST**

Size	Refrigerant charge	GWP	Type of circuit	Leakage check frequency
	kg	t equiv CO <sub>2</sub>		
0100	0,75	1,56600	NOT hermetically sealed	none mandatory check
0130	0,93	1,94184		none mandatory check
0160	1,40	2,92320		none mandatory check
0190	1,40	2,92320		none mandatory check
0210	1,80	3,75840		none mandatory check
0260	2,30	4,80240		none mandatory check
0300	2,48	5,17824		every 12 months
0350	3,75	7,83000		every 12 months
0450	4,50	9,39600		every 12 months
0580	4,45	9,29160		every 12 months
0750	9,80	20,46240		every 12 months
0950	10,30	21,50640		every 12 months
1100	12,60	26,30880		every 12 months
1400	12,60	26,30880		every 12 months
1500	16,50	34,45200		every 12 months
1700	17,00	35,49600		every 12 months
1900	18,50	38,62800		every 12 months
2200	17,60	36,74880		every 12 months
3000	27,60	57,62880		every 6 months
4500	38,00	79,34400		every 6 months



### 9.3 INFORMATION ABOUT CONTROLS

Units that require mandatory inspection must only be serviced by companies that prove to be F-GAS certified or who delegate the intervention to F-GAS certified personnel.

According to paragraph 5 of regulation 517/2014, equipment not hermetically sealed, charged with fluorinated greenhouse gases, can be sold to end users only if it is shown that the starting is carried out by an F-GAS certified company according to Article 10.

For controls it is advisable to use an electronic leak detector suitable for R410A with sensitivity 3 gr/year. Verify the absence of leaks from each junction point, charge connection and fixing of the refrigeration circuit.

The norm defines installation the starting of the equipment. In this document installation has been replaced by starting because installation activities without starting can also be performed by non-F-GAS certified personnel.

According to regulation 517/2014, who makes starting, checks, repairs, maintenance or dismantling on the units must enter (if certified F-GAS) or request the insertion (to certified personnel) of the intervention data in the F-GAS portal. The obligation begins 8 months after the entry into force of the D.P.R. 146/2018, that is from 24 September 2019.

The communication must be sent within 30 days from the intervention.

Following each intervention, the following information must be communicated:

- a. number and date of the invoice or purchase receipt of the equipment (only for starting)
- b. date and place of installation / maintenance / repair
- c. registry of the operator
- d. type of equipment
- e. unambiguous identification code of the equipment (brand / model / S.N.)
- f. quantity and type of fluorinated greenhouse gases present and in case added
- g. name and address of the recycling or regeneration plant and, where applicable, the certificate number, if the quantities of fluorinated greenhouse gases installed have been recycled or reclaimed
- h. identification data of the certified person or of the certified company that make the intervention
- i. date and type of intervention (only for control / maintenance / repair / dismantling)
- j. quantity and type of greenhouse gas recovered during the intervention (only for control / maintenance / repair / dismantling)
- k. measures taken to recover and dispose of the fluorinated gases contained in the equipment (only for dismantling)
- l. any comments

10 NOTES

---

---

---

---

---

---

---

---

---

---

---

---

---

---

---

---

---

---

---

---

---

---

---

---

---

---

---

---

---

---



# HiDew

Dehumidifiers 

HiDew S.r.l.

info@hidew.it - www.hidew.it

Operational Headquarter

Via dell'Artigianato, 5- 35026- Conselve (PD)- Italy  
Tel +39 049 9502511

Registered Office

Viale Spagna, 31/33- 35020- Tribano (PD)- Italy  
Tel +39 049 9588511- Fax +39 049 9588522